



STREAMLIGHT®

**PROFESSIONAL-GRADE
ILLUMINATION TOOLS**

SINCE 1973, WE'VE BEEN FOCUSED ON LIGHTING THE WAY IN INNOVATION. **WE'LL NEVER STOP.**

For 50 years, Streamlight has delivered effective, efficient high-performance lighting solutions featuring the latest technology, unmatched performance, unheard of durability and incredible value. We've earned our reputation one customer at a time. And although features or light output may change - our commitment to quality and innovation is the one constant that will always remain the same.



TABLE OF CONTENTS

STINGER SERIES	Stinger® 2020	Pg. 11	WEAPON-MOUNTED SERIES	TLR-1® // TLR-2® Series	Pgs. 83-87	
	Stinger LED HL® // Stinger® Color-Rite®	Pg. 12		TLR 3® // TLR-4® Series	Pg. 88	
	Stinger® HPL Series	Pg. 13		TLR-VIR® II	Pg. 89	
	Stinger® LED Series	Pg. 14		TLR-6® Series	Pgs. 90-93	
	UltraStinger® LED	Pg. 15		TLR-7® X // TLR-8® X Series	Pgs. 94-99	
PolyStinger® Series	Pg. 16	TLR-9® // TLR-10® Series		Pgs. 100-101		
STRION SERIES	Strion® 2020	Pg. 18		SpeedLocker®	Pg. 105	
	Strion LED HL® Series	Pg. 19		TLR® RM Series	Pgs. 106-109	
	Strion® HPL Series	Pg. 19		TLR-1 HPL®	Pg. 110	
	Strion® LED Series	Pg. 20		TL-Racker® Series	Pg. 111	
SL SERIES	SL Series	Pgs. 22-23		ProTac® Rail Mount Series	Pgs. 114-118	
			TACTICAL SERIES	Wedge® Series	Pgs. 122-123	
ProTac® Series	Pgs. 124-129					
PolyTac® Series	Pgs. 132-133					
Sidewinder® Series	Pgs. 128-144					
WORK LIGHT SERIES	Stinger Switchblade®	Pg. 29	USB RECHARGEABLE LITHIUM-ION BATTERY	SL-B50®	Pg. 137	
	Strion Switchblade®	Pg. 30		SL-B26®	Pgs. 134-135	
	Syclone® Series	Pg. 32		SL-B9®	Pg. 103	
	FlipMate®	Pg. 33		HEADLAMP SERIES	Headlamp Series	Pgs. 148-159
	BearTrap® Series	Pgs. 34-35			PENLIGHT SERIES	MicroStream® Series
LANTERN SERIES	Portable Scene Light Series	Pgs. 38-40	MacroStream® Series			Pg. 163
	Vulcan® 180 Series	Pgs. 42-43	Stylus® Series			Pgs. 165-167
	Vulcan Clutch®	Pg. 45	Stylus Reach® Series	Pg. 168		
	E-Flood® LiteBox® // E-Flood® FireBox®	Pg. 46	SPECIALTY SERIES	Specialty Series		Pg. 169
	E-Spot® LiteBox® // E-Spot® FireBox®	Pg. 46		STREAMLIGHT JR. SERIES	Streamlight Jr. F-Stop®	Pg. 170
Fire Vulcan® LED	Pg. 47	Streamlight Jr.® Series			Pg. 171	
HID LiteBox®	Pg. 48	POCKET LIGHT SERIES	Pocket Lights		Pgs. 172	
Waypoint® Series	Pgs. 50-51		DUALIE/PROPOLYMER SERIES	Dualie® Series	Pgs. 72-74	
Siege® Series	Pgs. 53-55			ProPolymer® Series	Pgs. 75-76	
SURVIVOR SERIES	Survivor® X Series	Pgs. 58-59		WEAPON-MOUNTED SERIES	TLR-1® // TLR-2® Series	Pgs. 83-87
	Survivor Pivot® Series	Pgs. 60-61			TLR 3® // TLR-4® Series	Pg. 88
	Survivor® Series	Pg. 62			TLR-VIR® II	Pg. 89
VANTAGE SERIES	Vantage® 180 X Series	Pg. 65	TLR-6® Series		Pgs. 90-93	
	Vantage®	Pg. 66	TLR-7® X // TLR-8® X Series		Pgs. 94-99	
	Vantage® II	Pg. 67	TLR-9® // TLR-10® Series	Pgs. 100-101		

LEADING THE INDUSTRY

WITH THE GREATEST VARIETY OF PROFESSIONAL GRADE LIGHTS:



STINGER® 2020
pg. 11



STINGER LED HL®
// DS LED HL®
pg. 12



STINGER®
COLOR-RITE®
pg. 12



STINGER HPL®
// DS® HPL
pg. 13



STINGER® LED
// DS® LED
pg. 14



ULTRASTINGER®
LED pg. 15



POLYSTINGER®
LED HAZ-LO®
pg. 16



POLYSTINGER®
LED // DS® LED
pg. 16



FLIPMATE®
pg. 33



BEARTRAP®
pg. 34



BEARTRAP® 360
pg. 35



PORTABLE SCENE
LIGHT pg. 38



PORTABLE SCENE
LIGHT II pg. 40



VULCAN® 180 SERIES
pgs. 42-43



VULCAN CLUTCH®
pg. 45



SUPER SIEGE®
pg. 53



THE SIEGE®
pg. 54



SIEGE® AA
pg. 54



SURVIVOR® X
// USB pg. 58



SURVIVOR
PIVOT®
pg. 61



SURVIVOR®
pg. 62



VANTAGE® 180 X
pg. 65



VANTAGE®
pg. 66



VANTAGE® II
pg. 67



PROTAC® 2.0
HEADLAMP pg. 149



PROTAC HL® USB
HEADLAMP pg. 150



PROTAC HL®
HEADLAMP pg. 150



BANDIT® // BANDIT®
PRO pg. 151



ENDURO® PRO USB
pg. 152



ENDURO® PRO
pg. 153



ENDURO®
pg. 153



TWIN-TASK® USB
pg. 159



MICROSTREAM®
pg. 162



MICROSTREAM®
USB pg. 162



MACROSTREAM®
USB pg. 163



STYLUS PRO®
USB SERIES
pg. 165



STYLUS PRO®
pg. 165



STYLUS®
SERIES
pg. 167



STYLUS
REACH®
pg. 168

STREAMLIGHT

PERFORMANCE. PERIOD.



STRION® 2020
pg. 18



**STRION LED HL®
// STRION® DS HL**
pg. 19



**STRION® HPL
// DS HPL®**
pg. 19



**STRION® LED
// STRION® DS**
pg. 20



SL-20L® // SL-20LP®
pgs. 22-23



**STINGER // STRION
SWITCHBLADE®**
pgs. 29-30



**SYCLONE®
SERIES** pg. 32



**E-FLOOD® LITEBOX®
// FIREBOX®**
pg. 46



**E-SPOT® LITEBOX®
// FIREBOX®**
pg. 46



FIRE VULCAN® LED
pg. 47



HID LITEBOX®
pg. 48



WAYPOINT®
pg. 50



WAYPOINT® 400
pg. 50



**DUALIE®
RECHARGEABLE**
pg. 72



DUALIE® 3AA
pg. 73



**DUALIE® 3AA
LASER** pg. 73



**DUALIE® 3AA
COLOR-RITE®**
pg. 74



DUALIE® 2AA
pg. 74



**2AAA // 2AA
PROPOLYMER®
HAZ-LO®** pg. 75



**STYLUS PRO®
HAZ-LO®** pg. 75



**4AA PROPOLYMER®
LED // LUX** pg. 76



**ENDURO® PRO
HAZ-LO®** pg. 154



**USB HAZ-LO®
HEADLAMP** pg. 155



3AA HAZ-LO®
pg. 156



SEPTOR®
pg. 156



ARGO®
pg. 156



TRIDENT®
pg. 157



**DOUBLE CLUTCH®
USB** pg. 158



CLIPMATE® USB
pg. 169



**STREAMLIGHT
JR. F-STOP®**
pg. 170



**STREAMLIGHT
JR. LED** pg. 159



**STREAMLIGHT JR.®
REACH** pg. 159



**POCKET MATE®
USB** pg. 172

LEADING THE INDUSTRY

WITH THE GREATEST VARIETY OF TACTICAL LIGHTS:



TLR-1 HL®
pg. 83



TLR-1 HL®-X
pg. 84



TLR-1® // TLR-1®s
pg. 85



TLR-2 HL®
pg. 86



TLR-2 HL® G
pg. 86



TLR-2® // TLR-2®s
pg. 87



TLR-2® G
pg. 87



TLR-3®
pg. 88



TLR-4® /
TLR-4® G
pg. 88



TLR-7® HL-X sub
pg. 98



TLR-7® X SUB
pg. 98



TLR-8® SUB
pg. 99



TLR-8® G SUB
pg. 99



TLR-9®
pg. 100



TLR-10®
pg. 101



TLR-10® G
pg. 101



SL-B9® BATTERY
PACK pg. 103



TLR-1 HPL®
pg. 110



TL-RACKER®
pg. 111



PROTAC® RAIL
MOUNT 1
pg. 114



PROTAC® RAIL
MOUNT 2
pg. 115



PROTAC® RAIL
MOUNT HL-X
pg. 115



PROTAC® RAIL
MOUNT HL-X
PRO pg. 116



PROTAC® RAIL
MOUNT HL-X
LASER pg. 117



PROTAC® 2.0
RAIL MOUNT
pg. 118



PROTAC® 90X
pg. 127



PROTAC HL® 6
pg. 128



PROTAC HL® 5-X
// USB pg. 128



PROTAC® HPL
USB pg. 129



PROTAC HL®
USB pg. 129



POLYTAC® X
pg. 132



POLYTAC 90® X
pg. 133



POLYTAC®
pg. 133

STREAMLIGHT

PERFORMANCE. PERIOD.



TLR-VIR® II
pg. 89



TLR-6®
pgs. 90-91



TLR-6 HL®
pgs. 92-93



TLR-7® X
pg. 94



TLR-7® X CONTOUR
REMOTE pg. 94



TLR-7® HL-X
USB pg. 95



TLR-8® A
pg. 97



TLR-8® AG
pg. 97



SPEEDLOCKER®
pg. 105



TLR® RM 1
pg. 106



TLR® RM 2
pg. 107



TLR® RM 1 LASER
pg. 108



TLR® RM 2 LASER
pg. 108



TLR® RM 1 LASER-G
pg. 109



TLR® RM 2 LASER-G
pg. 109



WEDGE® SERIES
pg. 122-123



PROTAC®
1L-1AA pg. 124



PROTAC® 2L
pg. 125



PROTAC HL®
pg. 125



PROTAC® 2AA-X
pg. 126



PROTAC® 2L-X
pg. 126



PROTAC® HL-X
pg. 127



SL-B26® BATTERY
PACK pgs. 134-135



PROTAC® 2.0
pg. 136



SL-B50® BATTERY
PACK pg. 137



SIDEWINDER
STALK®
pgs. 138-139



SIDEWINDER®
pg. 142



SIDEWINDER®
RESCUE
pg. 142



SIDEWINDER
COMPACT® II
pg. 143



SIDEWINDER
BOOT®
pg. 144

STINGER, STRION & SL SERIES //

DUTY & UTILITY LIGHTING SPECIALISTS
BECAUSE WORK IS TOUGH ENOUGH WITHOUT
HAVING TO WORRY ABOUT YOUR LIGHTING.

Streamlight Stingers, Strions and SL lights are trusted by law enforcement, professional mechanics and tradesmen around the world for a simple reason... they're the best. With the performance and features that they need and the durability they can depend on.



STINGER® 2020



STINGER DS® HPL



STRION® DS HL

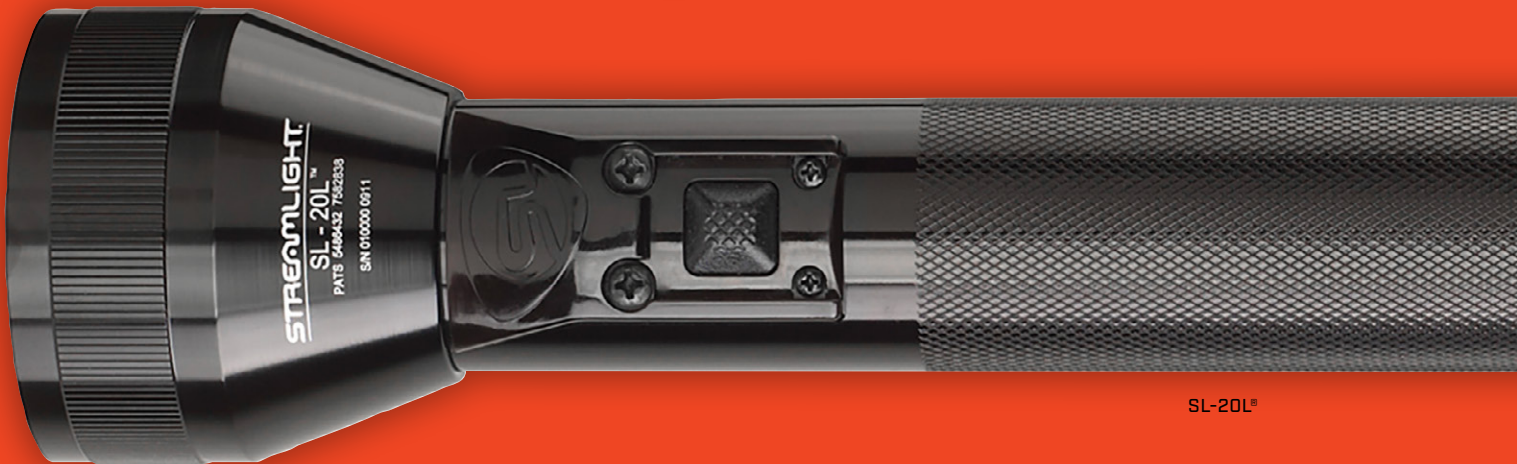

SL-20L®

STREAMLIGHT
STINGER SERIES



STINGER[®] 2020 HIGH-PERFORMANCE FLASHLIGHT



STINGER® 2020

The next evolution in high-performance, work-ready flashlights produces 2,000 lumens. Its aluminum alloy body with textured side panels and anti-roll design is ergonomically shaped for a sure grip. It features dual power switches and an intuitive mode selector switch for ease of use. Select high for brightest light or low for extended run time. Long-lasting SL-B26® USB rechargeable battery packs offer multiple charging options using existing Stinger smart chargers and bank chargers to charge inside the light; use a dual USB cord to charge the battery pack outside of the light or a Li-ion battery bank charger to charge multiple batteries at once. IPX7-rated; waterproof to 1m submersion, corrosion-resistant sealed glass lens.

	HIGH	MEDIUM	LOW
LUMENS:	2,000	850	100
CANDELA:	25,000	10,000	1,200
DISTANCE:	315m	200m	70m
RUN TIME:	2h	4h	24h

STROBE RUNS 3.25 HOURS

BATTERY: (2) SL-B26 Li-Ion USB rechargeable battery packs

SIZE: 7.67" x 1.62" (19.48 x 4.11 cm)

WEIGHT: 12.3 oz. (350g)

COLOR: Black, Red and Blue

[(STROBE)]

Double tap
switch to activate

ITEM #	DESCRIPTION
78101	Stinger 2020 - 120V/12V DC - Black
78121	Stinger 2020 - 120V/12V DC - Red
78131	Stinger 2020 - 120V/12V DC - Blue
78104	Stinger 2020 - 12V DC
78100	Stinger 2020 - Light Only - Includes "Y" micro USB cord - Black
78120	Stinger 2020 - Light Only - Includes "Y" micro USB cord - Red
78130	Stinger 2020 - Light Only - Includes "Y" micro USB cord - Blue

TAA COMPLIANT



**2,000
LUMENS**



STREAMLIGHT STINGER SERIES

STINGER LED HL® // STINGER DS LED HL®



The Stinger LED HL provides 800 lumens of maximum illumination. Its wide beam pattern gives you a bright flood light that will light up the area around you. Rubberized comfort grip. IPX4-rated; water-resistant.

	HIGH	MEDIUM	LOW
LUMENS:	800	400	200
CANDELA:	24,000	12,000	6,000
DISTANCE:	310m	219m	155m
RUN TIME:	1.5h	2.5h	5h

STROBE RUNS 3 HOURS

STINGER LED HL

BATTERY: NiMH Rechargeable

SIZE: 8.41" x 1.62" x 1.17"
(21.36 x 4.11 x 2.97 cm)

WEIGHT: 12.4 oz. (352g)

COLOR: Black

STINGER DS LED HL

BATTERY: NiMH Rechargeable

SIZE: 8.85" x 1.62" x 1.17"
(22.48 x 4.11 x 2.97 cm)

WEIGHT: 12.8 oz. (364g)

COLOR: Black

HL	DS HL	DESCRIPTION
75430	75454	120V AC/12V DC - 2 holders
75431	75455	120V AC
75432	75456	12V DC
75434	75458	120V AC/12V DC PiggyBack
75429	75453	Light Only

[(STROBE)]

Double tap
switch to activate



Available in both
dual switch and
standard styles



STINGER® COLOR-RITE®

	HIGH	MEDIUM	LOW
LUMENS:	500	275	140
CANDELA:	17,500	9,000	4,500
DISTANCE:	265m	190m	134m
RUN TIME:	1.5h	2.5h	5h

STROBE RUNS 3 HOURS
COLOR TEMPERATURE: 3,000K

**Color-
Rite®**

The Stinger Color-Rite features a warm white 90 CRI LED (3,000K) with Color-Rite Technology® that produces a more natural light so you can differentiate between paint or wire colors. Reduced glare prevents eye fatigue and helps cut through murky atmospheres. Ideal for low-light tracking and detecting trace evidence. IPX4-rated; water-resistant.

BATTERY: NiMH Rechargeable

SIZE: 8.41" x 1.62" x 1.17" (21.36 x 4.11 x 2.97 cm)

WEIGHT: 12.4 oz. (352g)

COLOR: Black



[(STROBE)]

Double tap
switch to activate

ITEM #	DESCRIPTION
75499	Stinger Color-Rite - 120V AC/12V DC
75502	Stinger Color-Rite - 120V AC/12V DC PiggyBack
75498	Stinger Color-Rite - Light Only

THE STINGER SERIES IS ALWAYS ON THE JOB IT'S A DUTY LIGHT BUILT WITH PRECISION & PERFORMANCE



STINGER HPL® // STINGER DS® HPL

	HIGH	MEDIUM	LOW
LUMENS:	800	400	200
CANDELA:	48,000	24,000	12,000
DISTANCE:	438m	310m	219m
RUN TIME:	1.5h	2.5h	5h

STROBE RUNS 3 HOURS



[(STROBE)]
Double tap
switch to activate



Available in both
dual switch and
standard styles

The Stinger HPL has combined two intensely bright illumination patterns into one multi-tasking beam giving you clarity up-close and deep into the horizon. Its long distance beam reaches 438 meters and the 800 lumen beam provides side to side visibility to fill in up-close areas and corners. IPX4-rated; water-resistant.

STINGER HPL

BATTERY: NiMH Rechargeable
SIZE: 9.23" x 2.20" x 1.17"
(23.44 x 5.59 x 2.97 cm)
WEIGHT: 13.6 oz. (385g)
COLOR: Black

STINGER DS HPL

BATTERY: NiMH Rechargeable
DS SIZE: 9.65" x 2.20" x 1.17"
(24.51 x 5.59 x 2.97 cm)
DS WEIGHT: 14.0 oz. (396g)
COLOR: Black

HPL	DS HPL	DESCRIPTION
75763	75863	120V AC/12V DC - 2 holders
75761	75861	120V AC
75799	75899	12V DC
75782	75882	120V AC/12V DC PiggyBack
75980	75900	Light Only



DUTY + TACTICAL HOLSTER
- Super-tough nylon construction
- Quick, Easy Access



THE STINGER IS FOUND
IN MORE TOOL BOXES
AND HOLSTERS FOR TWO SIMPLE REASONS...
PERFORMANCE AND DEPENDABILITY

STINGER® LED // STINGER DS® LED

The Stinger LED and Stinger DS LED deliver the optimal balance of performance and value with the longest run time in the Stinger family. The DS model provides both a tail and head switch. IPX4-rated; water-resistant.

STINGER LED

BATTERY: NiMH Rechargeable
SIZE: 8.41" x 1.62" x 1.17"
(21.36 x 4.11 x 2.97 cm)
WEIGHT: 12.4 oz. (352g)
COLOR: Black

STINGER DS LED

BATTERY: NiMH Rechargeable
DS SIZE: 8.85" x 1.62" x 1.17"
(22.48 x 4.11 x 2.97 cm)
DS WEIGHT: 12.8 oz. (364g)
COLOR: Black

	HIGH	MEDIUM	LOW
LUMENS:	425	200	100
CANDELA:	26,000	12,000	6,000
DISTANCE:	322m	219m	155m
RUN TIME:	3h	5.5h	10h
STROBE RUNS 7.5 HOURS			

LED	DS LED	DESCRIPTION
75713	75813	120V AC/12V DC - 2 Holders
75711	75811	120V AC
75712	75812	12V DC
75732	75832	120V AC/12V DC PiggyBack
75710	75810	Light Only



[(STROBE)]
Double tap
switch to activate



**FAR REACHING BEAM +
1,100 LUMENS...
THERE'S A REASON IT'S CALLED THE
ULTRASTINGER LED**

ULTRASTINGER® LED

The UltraStinger LED delivers a piercing 1,100 lumens, but that's not all - it also has a far-reaching beam, TEN-TAP® programming for its multiple intensities and a rubber sleeve for a better grip. IPX4-rated; water-resistant.

BATTERY: NiMH Rechargeable
SIZE: 11.82" x 2.37" x 1.19" (30 x 6.01 x 3 cm)
WEIGHT: 19.9 oz. (564g)
COLOR: Black

ITEM #	DESCRIPTION
77553	UltraStinger LED - 120V AC/12V DC - 2 Holders
77551	UltraStinger LED - 120V AC
77555	UltraStinger LED - 12V DC
77550	UltraStinger LED - Light Only

	HIGH	MEDIUM	LOW
LUMENS:	1,100	350	90
CANDELA:	65,000	21,000	5,000
DISTANCE:	510m	290m	141m
RUN TIME:	1.5h	4.5h	16h

STROBE RUNS 3.25 HOURS

[(STROBE)]
Double tap
switch to activate



TEN-TAP® Programmable - choose from three programs:

- high/med/low with strobe
- high only without strobe
- low/medium/high without strobe

BUILT FOR DURABILITY AND PERFORMANCE

POLYSTINGER® LED HAZ-LO®

A good choice for gas utility workers, the PolyStinger LED HAZ-LO is a durable, safety-rated, rechargeable light that delivers the performance you want with the safety ratings you need. Features a non-conductive, corrosion-resistant body and an unbreakable, scratch-resistant polycarbonate lens. IPX4-rated; water-resistant.

	HIGH	LOW
LUMENS:	260	80
CANDELA:	16,000	5,700
DISTANCE:	253m	151m
RUN TIME:	5h	16h
MOONLIGHT MODE RUNS 20 DAYS		



Class I, II, Div. 1, Groups C, D, F, G;
Class III, 138°C (T3C)
Non-Incendive: Class I, Div. 2
Groups A, B, C, D

BATTERY: NiMH Rechargeable
SIZE: 10.2" x 1.76" x 1.34" (25.9 x 4.47 x 3.4 cm)
WEIGHT: 13.5 oz. (382g)
COLOR: Black or Yellow

YELLOW	BLACK	DESCRIPTION
76412	76442	120V AC/12V DC
76411	76441	12V DC
76410	76440	Light Only

POLYSTINGER® LED // POLYSTINGER DS® LED

Intense brightness, long-range and long run time in a durable nylon polymer housing. It's the ideal combination of power, performance and durability. The DS model has the convenience of two full-function, independent switches: one on the head and a tail switch.

	HIGH	MEDIUM	LOW
LUMENS:	485	240	120
CANDELA:	28,000	14,000	7,000
DISTANCE:	335m	237m	167m
RUN TIME:	3h	5.5h	10h
STROBE RUNS 7.5 HOURS			































[(STROBE)]
Double tap
switch to activate

POLYSTINGER LED
BATTERY: NiMH Rechargeable
SIZE: 8.07" x 1.76" x 1.21"
(20.50 x 4.47 x 3.07 cm)
WEIGHT: 11.5 oz. (326g)
COLOR: Black or Yellow

POLYSTINGER DS LED
BATTERY: NiMH Rechargeable
SIZE: 8.64" x 1.76" x 1.21"
(21.95 x 4.47 x 3.07 cm)
WEIGHT: 11.9 oz. (338g)
COLOR: Black

LED	DS LED	DESCRIPTION
76163	---	120V AC/12V DC - Yellow - 2 Holders
76113	76813	120V AC/12V DC - Black - 2 Holders
76161	---	120V AC - Yellow
76111	76811	120V AC - Black
76162	---	12V DC - Yellow
76112	76812	12V DC - Black
76182	---	120V AC/12V DC PiggyBack - Yellow
76132	76832	120V AC/12V DC PiggyBack - Black
76160	---	Light Only - Yellow
76110	76810	Light Only - Black

STINGER ACCESSORIES

DESCRIPTION	STINGER 2020	STINGER COLOR-RITE	DS LED HL LED HL	DS HPL HPL	DS LED LED	ULTRASTINGER LED	POLYSTINGER LED HAZ-LO	POLYSTINGER LED /DS LED
5 Unit Bank Charger 	75400	75400	75400	75400	75400	75400	75400	75400
Smart Charger 	75105	75105	75105	75105	75105	75105	75105	75105
PiggyBack® Charger 	—	75277	75277	75277	75277	—	—	75277
NiMH Battery Stick 	—	75375	75375	75375	75375	77375	76375	75375
Li-Ion Battery Stick 	—	75176	75176	75176	75176	—	—	75176
SL-B26 Battery Pack 	78105	—	—	—	—	—	—	—
12V DC Car Charge Cord 	22051	22051	22051	22051	22051	22051	22051	22051
12V DC Charge Cord 	22050	22050	22050	22050	22050	22050	22050	22050
120V AC Charge Cord 	22071	22071	22071	22071	22071	22071	22071	22071
Leather Plain Holster 	—	75133	75133	—	75133	—	—	75133
Leather Weave Holster 	78114	75134	75134	—	75134	—	—	75134
Nylon Holster 	—	75927	75927	75927	75927	—	—	75910
Nylon Holster 	78107	—	—	—	—	—	—	—
Loop Nylon Holster 	—	75928	75928	75928	75928	75928	75928	75928
Duty Holster 	—	88053	88053	88053	88053	88053	—	—
Ring Holder 	—	75906	75906	75906	75906	75906	75906	75906
Flip Lens Red 	75115	75115	75115	—	75115	—	—	—
Flip Lens Blue 	75116	75116	75116	—	75116	—	—	—
Flip Lens Green 	75117	75117	75117	—	75117	—	—	—
Red Wand 	75903	75903	75903	75946	75903	78903	—	75933
White Wand 	75908	75908	75908	75949	75908	—	—	75938
Blue Wand 	75902	75902	75902	75947	75902	—	—	75932
Yellow Wand 	75904	75904	75904	75948	75904	78904	—	75934
Glow in the Dark Wand 	75913	75913	75913	75950	75913	78913	—	75943
Micro-USB Cord 	22081 - 22" (55.8 cm) 22070 - 40" (101.9 cm)	—	—	—	—	—	—	—
"Y" Micro-USB Cord 	22082	—	—	—	—	—	—	—
12V DC USB Adapter 	22069	—	—	—	—	—	—	—
Face cap Ring Kit 	78113	—	—	—	—	—	—	—

STRION® 2020 // NEW

The Strion 2020 features independently functioning head and tail switches along with an intuitive mode select switch for ease of use. Select high for brightest light or low for extended run time. Long-lasting lithium-ion rechargeable battery offers multiple charging options using existing Strion® smart chargers and bank chargers. IPX7-rated; waterproof to 2m. Corrosion-resistant sealed glass lens. Fits long gun mounts.



BATTERY: Lithium-ion
SIZE: 6.33" x 1.25" x 0.95" (16.1 x 3.18 x 2.41 cm)
WEIGHT: 5.7 oz. (161.6g)
COLOR: Black

ITEM #	DESCRIPTION
74431	Strion 2020 - 120V AC/12V DC - 1 Holder
74435	Strion 2020 - 120V AC/12V DC PiggyBack
74434	Strion 2020 - 12V DC
74430	Strion 2020 - Light Only

	HIGH	MEDIUM	LOW
LUMENS:	1,200	460	120
CANDELA:	28,000	10,500	3,000
DISTANCE:	335m	200m	110m
RUN TIME:	1.75h	5.5h	12h
STROBE RUNS 3.5 HOURS			

[(STROBE)]
 Double tap
 switch to activate



NEW Strion HC (high capacity) battery 74436 works with all of our products that take existing Strion battery 74175



Independently functioning head and tail switches

Mode intensity switch for easy selection of High, Medium or Low



Battery status indicator:
 Green = Charged
 Red = Needs to be charged



PiggyBack® Charger

STRION LED HL® // STRION® DS HL

The Strion LED HL provides a high lumen beam with maximum illumination. Its wide beam pattern gives you a bright flood light that will light up the area around you. IPX4 water-resistant. Fits long gun mounts.

STRION LED HL

BATTERY: Lithium-ion
SIZE: 5.90" x 1.25" x 0.95"
(14.99 x 3.18 x 2.41 cm)
WEIGHT: 5.2 oz. (148g)
COLOR: Black

STRION DS HL

BATTERY: Lithium-ion
SIZE: 6.33" x 1.25" x 0.95"
(16.08 x 3.18 x 2.41 cm)
WEIGHT: 5.4 oz. (153g)
COLOR: Black

STRION LED HL	HIGH	MEDIUM	LOW
LUMENS:	615	320	160
CANDELA:	12,000	6,000	3,000
DISTANCE:	219m	155m	110m
RUN TIME:	1.25h	2.5h	4.5h

STROBE RUNS 3 HOURS

STRION® HPL // STRION® DS HPL

Lightweight and ultra-compact, yet extremely powerful. It throws its long beam far out in the distance while casting plenty of peripheral light along the way. Features three intensities plus strobe. Rechargeable battery and powerful illumination result in one of the lowest operating costs of any flashlight. Easy, one-handed operation with multi-function push-button tailswitch.

STRION HPL

BATTERY: Lithium-ion
SIZE: 7.00" x 2.2" x 0.95"
(17.78 x 5.59 x 2.41 cm)
WEIGHT: 7.1 oz. (202g)
COLOR: Black

STRION DS HPL

BATTERY: Lithium-ion
SIZE: 7.56" x 2.2" x 0.95"
(19.2 x 5.59 x 2.41 cm)
WEIGHT: 6.9 oz. (196g)
COLOR: Black

STRION HPL	HIGH	MEDIUM	LOW
LUMENS:	615	320	160
CANDELA:	40,000	20,000	10,000
DISTANCE:	400m	283m	200m
RUN TIME:	1.25h	2.5h	4.5h

STROBE RUNS 3 HOURS



[(STROBE)]

Double tap switch to activate

STRION DS HL	HIGH	MEDIUM	LOW
LUMENS:	700	300	40
CANDELA:	12,000	5,000	800
DISTANCE:	219m	141m	57m
RUN TIME:	1.25h	3.5h	24h

STROBE RUNS 2.5 HOURS

- DS model features **TEN-TAP®** Programmable - choose from three programs:
- high/med/low with strobe
 - high only without strobe
 - low/medium/high without strobe

HL	DS HL	DESCRIPTION
74752	74612	120V AC/12V DC - 2 Holders
74751	74611	120V AC/12V DC - 1 Holder
74755	74621	120V AC/12V DC - 1 Holder - Clam
74778	74619	120V AC/12V DC PiggyBack
74753	74613	120V AC
74509	74620	120V AC - with Grip Ring
74754	74614	12V DC
74750	74610	Light Only



[(STROBE)]

Double tap switch to activate

STRION DS HPL	HIGH	MEDIUM	LOW
LUMENS:	700	300	40
CANDELA:	44,000	18,000	2,600
DISTANCE:	420m	268m	102m
RUN TIME:	1.25h	3.5h	24h

STROBE RUNS 2.5 HOURS

- DS model features **TEN-TAP®** Programmable - choose from three programs:
- high/med/low with strobe
 - high only without strobe
 - low/medium/high without strobe

HPL	DS HPL	DESCRIPTION
74502	74812	120V AC/12V DC - 2 Holders
74501	74811	120V AC/12V DC - 1 Holder
74536	74819	120V AC/12V DC PiggyBack
75503	74813	120V AC
74504	74814	12V DC
74500	74810	Light Only

STREAMLIGHT STRION SERIES



STRION® LED // STRION® DS

A powerful value that's perfect for the broadest range of lighting needs. IPX4-rated for water-resistance. Anti-roll ring included. Optional model with adjustable Grip Ring provides a sure-grip for easy one-handed operation.

STRION LED

BATTERY: Lithium-ion
SIZE: 5.9" x 1.25" x 0.95"
(14.99 x 3.18 x 2.41 cm)
WEIGHT: 5.2 oz. (148g)
COLOR: Black

STRION DS

BATTERY: Lithium-ion
SIZE: 6.4" x 1.25" x 0.95"
(16.26 x 3.18 x 2.41 cm)
WEIGHT: 5.4 oz. (153g)
COLOR: Black

STRION LED	HIGH	MEDIUM	LOW
LUMENS:	375	175	80
CANDELA:	12,000	6,500	3,200
DISTANCE:	219m	161m	113m
RUN TIME:	2.5h	4.75h	9.5h

STROBE RUNS 6.5 HOURS



[(STROBE)]

Double tap
switch to activate

STRION DS	HIGH	MEDIUM	LOW
LUMENS:	375	150	40
CANDELA:	12,000	5,000	1,300
DISTANCE:	219m	141m	72m
RUN TIME:	2.5h	6.25h	24h

STROBE RUNS 5 HOURS

LED	DS	DESCRIPTION
74302	74412	120V AC/12V DC - 2 Holders
74301	74411	120V AC/12V DC - 1 Holder
74353	74419	120V AC/12V DC PiggyBack
74303	74413	120V AC
74309	74420	120V AC - with Grip Ring
74304	74414	12V DC
74300	74410	Light Only

DS model features **TEN-TAP®** Programmable

- choose from three programs:

- high/med/low with strobe
- high only without strobe
- low/medium/high without strobe

STRION ACCESSORIES

DESCRIPTION	STRION / DS LED HL	STRION HPL / DS HPL	STRION / STRION DS	STRION 2020
6 Unit Bank Charger 120V 	74400	74400	74400	74400
6 Unit Bank Charger DC 	74401	74401	74401	74401
Piggyback Charger Holder 	74115	74115	74115	---
Smart Charger Holder 	74102	74102	74102	74102
Li-ion Battery Stick Strion Series 	74175	74175	74175	---
Li-ion Battery Stick Strion 2020 	74436	74436	74436	74436
12V DC1 Charge Cord 	22051	22051	22051	22051
12V DC2 Charge Cord 	22050	22050	22050	22050
120V USB Charge Cord 	22071	22071	22071	22071
Rail Mount 	74200	74200	74200	74200
Vertical Grip 	69114	69114	69114	69114
Leather Plain Holster 	74059	---	74059	74059
Leather Weave Holster 	74060	---	74060	74060
Nylon Holster 	85905	---	85905	85905
Tactical Holster 	88051	88051	88051	88051
Red Flip Lens 	85115	---	85115	85115
Green Flip Lens 	85117	---	85117	85117
Blue Flip Lens 	85116	---	85116	85116
Red Wand 	74903	75946	74903	74903
Yellow Wand 	74904	75948	74904	74904
Glow in the Dark Wand 	74913	75950	74913	74913

STREAMLIGHT
SL-20L SERIES



SL-20L®

Full-size, professional grade light that delivers the intense brightness and run times you need for a wide variety of jobs. Unbreakable, scratch-resistant lens. IPX4-rated; water-resistant.

BATTERY: NiMH Rechargeable
SIZE: 13.1" x 2.5" x 1.5"
(33.3 x 6.35 x 3.81 cm)
WEIGHT: 1.7 lbs. (770g)
COLOR: Black



[(STROBE)]
Double tap
switch to activate

ITEM #	DESCRIPTION
20703	SL-20L - 120V AC/12V DC - 2 sleeves
20701	SL-20L - 120V AC
20702	SL-20L - 12V DC
20700	SL-20L - Light Only

	HIGH	MEDIUM	LOW
LUMENS:	450	225	60
CANDELA:	70,000	35,000	9,000
DISTANCE:	529m	374m	189m
RUN TIME:	3.25h	5h	20h
STROBE RUNS 4.5 HOURS			

A HISTORY OF PERFORMANCE, THE LEGENDARY FULL-SIZE DUTY LIGHT



SL-20LP®

	HIGH	MEDIUM	LOW
LUMENS:	450	225	60
CANDELA:	70,000	35,000	9,000
DISTANCE:	529m	374m	189m
RUN TIME:	3.25h	5h	20h

STROBE RUNS 4.5 HOURS

Feature packed, the SL-20LP full sized professional grade, high-intensity, rechargeable flashlight offers high, medium, low and strobe modes. Lightweight, polymer construction, unbreakable, scratch-resistant lens. IPX4-rated; water-resistant.

BATTERY: NiMH Rechargeable
SIZE: 13.2" x 2.5" x 1.5" (33.5 x 6.35 x 3.81 cm)
WEIGHT: 1.3 lb (590g)
COLOR: Black, Yellow or Orange

ITEM #	DESCRIPTION
25323	SL-20LP - 120V AC/12V DC - 2 sleeves - Yellow
25303	SL-20LP - 120V AC/12V DC - 2 sleeves - Black
25313	SL-20LP - 120V AC/12V DC - 2 sleeves - Orange
25321	SL-20LP - 120V AC - Yellow
25301	SL-20LP - 120V AC - Black
25311	SL-20LP - 120V AC - Orange
25322	SL-20LP - 12V DC - Yellow
25302	SL-20LP - 12V DC - Black
25312	SL-20LP - 12V DC - Orange
25320	SL-20LP - Light Only - Yellow
25300	SL-20LP - Light Only - Black
25310	SL-20LP - Light Only - Orange

[(STROBE)]
 Double tap
 switch to activate

ACCESSORIES

DESCRIPTION	SL-20L	SL-20LP
5-Unit Bank Charger 120V AC	21400	21400
5-Unit Bank Charger 12V DC	21401	21401
Charger Holder	22047	22047
12V DC1 Charge Cord	22051	22051
12V DC2 Charge Cord	22050	22050
120V AC Charge Cord	22060	22060
NiMH Battery Stick	77375	77375
Nylon Holster	25090	25090
Red Wand	22511	22511
Blue Wand	22512	22512
Yellow Wand	22519	22519
Glow In the Dark Wand	22513	22513

WORK LIGHT SERIES //

WORK LIGHT SPECIALISTS

**IN THE GARAGE, ON THE WORK TRUCK OR IN THE FIELD,
STREAMLIGHT DELIVERS LIGHT WHERE YOU NEED IT.**

At Streamlight we innovate lighting solutions that make sense.

We build lighting tools that put function right alongside performance and convenience. That's exactly what our family of work lights is designed to deliver. With innovative charging systems and light delivery, we make it easier for you to get the job done.



STINGER SWITCHBLADE®

STRION SWITCHBLADE®

BEARTRAP® 360

SYCLONE®

FLIPMATE®

// COLOR-RITE TECHNOLOGY®

// WHAT IS COLOR-RITE TECHNOLOGY?

Color-Rite Technology is based on the Color Rendering Index (CRI) -- a scale from 0-100 that indicates how a light source reflects color variations as they appear to the human eye. The higher the CRI, the more vibrant the colors appear. On the scale, lights that measure 90+ are considered "high" CRI lights and are critical for tasks requiring the most accurate color discrimination. A perfect 100 would enable us to see colors as they appear in natural sunlight.

// WHY STREAMLIGHT COLOR-RITE TECHNOLOGY?

Flashlights equipped with Streamlight's proprietary Color-Rite Technology allow users to see the color spectrum as they would in natural light. While a standard high-lumen LED light produces an ultra-bright white beam that is needed in many applications, it prevents seeing subtle color differences in, for example, auto body paint colors or electrical wiring. In contrast, a high CRI light provides a softer, warmer beam to prevent color "washout," allowing the user to see specific colors or imperfections and subtle details, regardless of the task.

// COLOR-RITE® APPLICATIONS FOR EVERY SITUATION

Streamlight offers a family of Color-Rite® lights for situations that require detailed inspections or color differentiation. For markets as diverse as automotive, industrial, law enforcement, military and even outdoor recreation, we have developed high CRI lights with Color-Rite Technology® for a wide variety of tasks that require exacting attention to detail. From repairing electrical wires to inspecting paint finishes or examining forensic evidence, count on Streamlight's Color-Rite® products help get the job done efficiently and safely.

Our family of Color-Rite® products include the following:



STINGER® COLOR-RITE®

Rechargeable, warm white (3,000K)
90 CRI LED with Streamlight's
Color-Rite Technology



DUALIE® 3AA COLOR-RITE®

Intrinsically safe multi-function dual beam flashlight
with a cool white LED and a warm white (4,000K)
90 CRI LED with Streamlight's Color-Rite Technology



STINGER SWITCHBLADE®

Five lights in one:
Drop Light | Hands-Free | White Light |
Color-Rite Light (4,000K) | UV Light



STRION SWITCHBLADE®

Five lights in one:
Drop Light | Hands-Free | White Light |
Color-Rite Light (4,000K) | UV Light



SYCLONE®

Ultra-compact work light with a cool white LED
and a warm white (4,000K) 90 CRI LED with
Streamlight's Color-Rite Technology



FLIPMATE®

Compact work light with cool white LEDs and warm
white (4,000K) 90 CRI LEDs with Streamlight's Color-Rite
Technology - each with high and low modes

// A LIGHT FOR EVERY SITUATION

// COLOR-RITE® APPLICATIONS BY MARKET

LAW ENFORCEMENT/MILITARY

- **Improve tracking in low-light conditions.** High CRI lights like the Stinger Color-Rite help border patrol and other law enforcement agencies reveal subtle details of tracks and other markings that white LEDs with their bright “hot spots” can miss.
- **Detect trace evidence.** Forensic teams can more clearly spot fingerprints, fibers and other trace evidence on glass and other slick surfaces with high CRI lights such as the Stinger Color-Rite.
- **Enhance visualization.** High CRI lights can help cut through murky lake or ocean water, thick smoke or fog, and even heavy dust when pursuing vehicles in rough terrain.

AUTOMOTIVE

- **Match and identify colors.** The Dualie 3AA Color-Rite, FlipMate, Stinger Switchblade, Cyclone and Strion Switchblade are ideal for color matching and identifying body imperfections before and after paint repairs.
- **Identify defects.** Paint defects such as swirl marks and color sanding scratches are easily identifiable with high CRI LEDs.
- **Distinguish colors.** When troubleshooting electrical short circuits or other motor vehicle repairs, high CRI lights assist in differentiating colored wires in hard-to-see areas under a hood or carriage.
- **Reduce glare when working in tight spaces.** Because high CRI LEDs reflect back less light than bright white LEDs, mechanics can see greater detail when working in dark, hard-to-reach places underneath a car or under the hood.



INDUSTRIAL

- **Differentiate wire colors in electrical panels.** In plants and other facilities, high CRI lights like the Dualie 3AA Color-Rite, FlipMate and Cyclone provide better color contrast of intricate wires in electrical cabinets, helping technicians to work more efficiently.
- **Spot imperfections.** High CRI lights allow for contrast of color to identify imperfections in finish inspections of products including parts.
- **Reduce eye fatigue.** The soft lighting of high CRI LEDs reduces eye strain and fatigue for many users.

FIRE/RESCUE/EMS

- When responding to fires, accidents or other events under low light conditions, high CRI area lights such as the Dualie 3AA Color-Rite, Stinger Switchblade and Stinger Color-Rite can be essential tools, permitting first responders to **see the color spectrum as they would in natural daylight.**
- High CRI lights allow investigators to **see specific colors, imperfections and subtle details** when examining fire or accident scenes and gathering evidence.

OUTDOOR RECREATION

- **Identify blood trails.** State-of-the-art blood trailing technology in high CRI lights, such as the Stinger Color-Rite, reduces certain colors in the spectrum to better amplify blood trails.
- **Visualize in low-light conditions.** Hikers and other outdoor enthusiasts use high CRI lights like the Dualie 3AA Color-Rite to better see obstacles when navigating trails at night and under other low-light conditions.

STREAMLIGHT
WORK LIGHT SERIES

THE STINGER SWITCHBLADE
SPENDS AS MUCH TIME
UNDER THE CAR
AND COVERED
IN GREASE AS YOU
A PERFECT MATCH



28



STINGER SWITCHBLADE®

The Stinger Switchblade rechargeable area light is five lights in one: a droplight, hands-free light, UV light, bright white light and a warm white (4000K) high CRI light with Streamlight's Color-Rite Technology®. The blade of the Switchblade can rotate 180° on the body. Soft detents will hold the blade in your desired position, and the light will stand on its tail with the light bar in any position. There are multiple ways to hook and hang the light. Use the hooks on the base plate or the retractable hook for many hanging options. The weighted base also includes magnets that will hold the light (in any orientation) to provide task-specific illumination.



BATTERY: Lithium-ion
FOLDED SIZE: 9.80" x 1.62" x 1.40"
 (24.89 x 4.11 x 3.56 cm)
EXTENDED LENGTH: 17.0" (43.18 cm)
WEIGHT: 17.1 oz. (485g)
COLOR: Red

ITEM #	DESCRIPTION
76801	Stinger Switchblade - 120V AC - 1 Holder
76800	Stinger Switchblade - Includes micro USB cord



180° rotating light bar aims the beam where you need it.

Color-Rite®



Hands-free applications:
Tail-end magnet, stowable hang hook and stable foot

	COOL WHITE	HIGH CRI (90) WARMWHITE	UV LED
LUMENS:	800	600	500 mW
RUN TIME:	3.75h	3.75h	15h
COLOR TEMPERATURE: 4,000K			

ACCESSORIES

5 Unit Bank Charger		75400
Charger		75105
Li-Ion Battery Stick		76805
12V DC Car Charge Cord		22051
12V DC Charge Cord		22050
120V AC Charge Cord		22071
Micro-USB Cord		22081 - 22" (55.8 cm) 22070 - 40" (101.9 cm)
12V DC USB Adapter		22069

Double-Sided Light bar:

- 90 CRI LEDs - Color-Rite Technology - warm white light (4000K) allows you to distinguish between similar colors - for paint matching, checking wires, etc.
- Cool white LEDs for bright, white light
- UV LED for leak detection

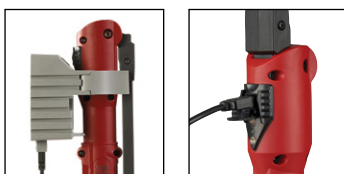

Dual charging options:
Charge using existing Stinger chargers or charge via USB source

STREAMLIGHT WORK LIGHT SERIES

STRION SWITCHBLADE®

Inspect, identify and repair with the Strion Switchblade. It's five lights in one: a droplight, hands-free light, UV light, bright white light and a warm white (4000K) high CRI light with Streamlight's Color-Rite Technology. Lithium-ion battery charges in 4 hours. Charge using existing Strion chargers or USB source. You can work harder for longer with the PiggyBack® charger and easy-to-change battery - just twist off the endcap, replace and go.

BATTERY: Lithium-ion

FOLDED SIZE: 6.0" x 1.18" x 0.99" (15.24 x 3.0 x 2.51 cm)

EXTENDED LENGTH: 10.75" (27.30 cm)

WEIGHT: 6.4 oz. (181g)

COLOR: Red

ITEM #	DESCRIPTION
74850	Strion Switchblade - Includes micro USB cord
74851	Strion Switchblade - 120V AC - 1 Holder
74854	Strion Switchblade - 120V AC PiggyBack



Hands-free applications:
Tail-end magnet, stowable hang hook and stable foot



Multiple charging options:
Charge using PiggyBack® Chargers, existing Strion chargers or charge via USB source



Double-Sided Light bar:

- 1.) Color-Rite Technology - warm white light (4000K) allows you to distinguish between similar colors - for paint matching, checking wires, etc.
- 2.) UV LED for leak detection
- 3.) Cool white LEDs for bright, white light



180° rotating light bar aims the beam where you need it.

Color-Rite®

	COOL WHITE	HIGH CRI (90) WARM WHITE	UV LED
LUMENS:	500	400	500 mW
RUN TIME:	3h	3h	5h
COLOR TEMPERATURE: 4,000K			



ACCESSORIES

6 Unit Bank Charger 120V		74400
6 Unit Bank Charger DC		74401
PiggyBack Charger Holder		74115
Charger Holder		74102
Li-ion Battery Stick		74175
12V DC1 Charge Cord		22051
12V DC2 Charge Cord		22050
120V USB Charge Cord		22071

**STREAMLIGHT
WORK LIGHT SERIES**

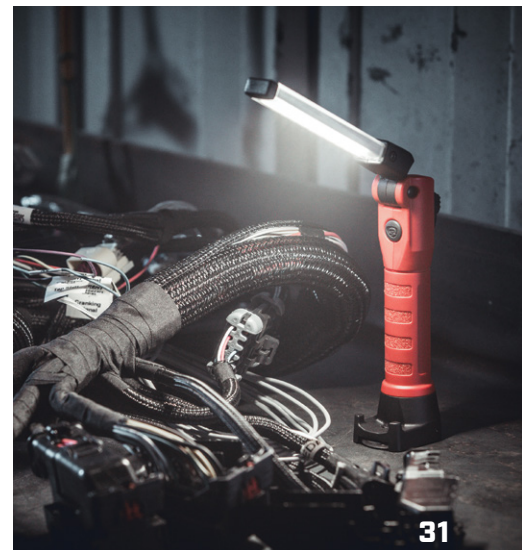

STREAMLIGHT WORK LIGHT SERIES

SYCLONE®

Inspect, identify and repair with the Syclone. It produces bright white light for everyday use or warm white (4,000K) high CRI light with Streamlight's Color-Rite Technology® for paint matching or identifying color differences in wires. Ultra-compact design doesn't get in the way and fits in small spaces. Go hands-free with the flat, magnetic base and stowable hook. USB rechargeable. 360° rotating body aims the beam where you need it; easy to rotate with one hand - no need to juggle tools.

BATTERY: Lithium Polymer Rechargeable
SIZE: 2.97" x 2.79" x 1.42" (7.54 x 7.08 x 3.6 cm)
WEIGHT: 5.3 oz. (150g)
COLOR: Red



Multi-function push-button switch with charge indicator.
 Battery charges in approx. 4.5 hours



**Color-
Rite®**



Hands-free applications:
 1.) Magnetic base
 2.) Stowable hang hook



SPOT/COOL WHITE	HIGH	MEDIUM	LOW
LUMENS:	400	200	100
DISTANCE:	141m	95m	72m
RUN TIME:	2h	4.5h	9.5h

FLOOD/WARM WHITE 90 CRI	HIGH	MEDIUM	LOW
LUMENS:	300	150	75
DISTANCE:	48m	35m	24m
RUN TIME:	2h	4h	8h

COLOR TEMPERATURE: 4,000K

ITEM #	DESCRIPTION
61510	Syclone - Includes micro USB cord

SYCLONE® JR.

Inspect, identify and repair with the Syclone Jr. It produces bright white light for everyday use. Ultra-compact design doesn't get in the way and fits in small spaces. Go hands-free with the flat, magnetic base and stowable hook. USB rechargeable. 360° rotating body aims the beam where you need it; easy to rotate with one hand - no need to juggle tools.

BATTERY: Lithium Polymer Rechargeable
SIZE: 2.04" x 2.25" x 1.14" (5.18 x 5.71 x 2.89 cm)
WEIGHT: 2 oz. (57g)
COLOR: Red



Multi-function push-button switch with charge indicator.
 Battery charges in approx. 4.5 hours



Hands-free applications:
 1.) Magnetic base
 2.) Stowable hang hook



	HIGH	LOW
LUMENS:	210	85
DISTANCE:	79m	49m
RUN TIME:	3.75h	8.5h

ITEM #	DESCRIPTION
61530	Syclone Jr. - Includes micro USB cord

FLIPMATE®

Inspect, identify and repair with the super-compact FlipMate. It produces bright white light for everyday use or warm white (4,000K) high CRI light with Streamlight's Color-Rite Technology® to identify color differences in paint or wires. Fits comfortably in the palm of your hand, allowing you to illuminate hard-to-get-to spaces, like under the dash. Go hands-free with the flat, magnetic base and stowable hook. USB rechargeable.



270° rotating light bar aims the beam where you need it



Hands-free applications:
1.) Magnetic base
2.) Stowable hang hook
3.) Foot provides stability to stand on end

BATTERY: Lithium-Ion
SIZE: Folded length: 4.58" (11.63 cm) // Extended length: 7.94" (20.17 cm)
WEIGHT: 8.7 oz. (247g)
COLOR: Black, Red or Blue

ITEM #	DESCRIPTION
61500	FlipMate - Includes micro USB cord - Black
61501	FlipMate - Includes micro USB cord - Red
61502	FlipMate - Includes micro USB cord - Blue

Color-Rite®

COOL WHITE	HIGH	LOW
LUMENS:	500	250
RUN TIME:	4h	5.75h

90 CRI WARM WHITE	HIGH	LOW
LUMENS:	400	200
RUN TIME:	4h	6h
COLOR TEMPERATURE: 4,000K		



Double-function light bar:
1.) 90 CRI LEDs - Color-Rite Technology - distinguish between similar colors - for paint matching, checking wires, etc.
2.) Cool white LEDs for bright, white light
Each with high and low modes





BEARTRAP[®]

Inspect, identify and repair with the multi-function BearTrap worklight. High power with big performance. It produces bright white light in both spot and flood modes. Lithium-ion battery charges in 5.5 hours; continues to charge while plugged in and in use. Features a secure cord connection to prevent snags. Multi-function push-button power switch with battery life indicator that lets you know when it needs to be to charged.

Go hands-free - it clamps virtually anywhere or stands on its own, allowing you to illuminate hard-to-get-to spaces like under the dash; also features a magnetic base and stowable hook.

Tough thermoplastic construction. Chemical-resistant lens - withstands most common automotive chemicals. IPX4-rated water resistant; 1m impact resistance tested.

BATTERY: Lithium-ion
SIZE: 7.62 x 6.5 x 3.12" (19.37 x 16.51 x 7.94 cm)
WEIGHT: 2 lbs. 3 oz. (992g)
COLOR: Red

FLOOD	HIGH	MEDIUM	LOW
LUMENS:	2,000	1,000	575
CANDELA:	1,200	680	360
DISTANCE:	69m	52m	38m
RUN TIME:	2.5h	5h	8.75h
SPOT	HIGH	MEDIUM	LOW
LUMENS:	1,000	450	325
CANDELA:	7,500	3,600	2,500
DISTANCE:	174m	120m	100m
RUN TIME:	4.5h	8.75h	12.5h

2,000
LUMENS



ITEM #	DESCRIPTION
61520	BearTrap - 120V/100V AC
44922	120V AC Cord
44923	12V DC Cord
61522	Lithium-ion Battery

BEARTRAP® 360 // **NEW**

Inspect, identify and repair with the multi-function BearTrap 360 work light featuring a 360° rotating and 270° pivoting body. It produces bright white light in both spot and flood modes. Flood fills your work area with evenly dispersed, bright light; Spot provides a concentrated beam - each with high, medium and low modes.

Go hands-free - it clamps virtually anywhere or stands on its own, allowing you to illuminate hard-to-reach spaces like under the dash; also features a magnetic base. Rubberized grip surface designed to prevent scratches.

Tough thermoplastic construction. Chemical-resistant lens - withstands most common automotive chemicals. IPX4-rated; water resistant; 1m impact-resistance tested.

FLOOD	HIGH	MEDIUM	LOW
LUMENS:	2,000	1,000	575
CANDELA:	1,200	680	360
DISTANCE:	69m	52m	38m
RUN TIME:	2.5h	5h	8.75h

SPOT	HIGH	MEDIUM	LOW
LUMENS:	1,000	450	325
CANDELA:	7,500	3,600	2,500
DISTANCE:	174m	120m	100m
RUN TIME:	4.5h	8.75h	12.5h

BATTERY: Lithium-Ion
SIZE: 7.62 x 6.5 x 3.12" (19.36 x 16.51 x 7.93 cm)
WEIGHT: 2 lbs. 5 oz. (1049g)
COLOR: Red



**2,000
LUMENS**

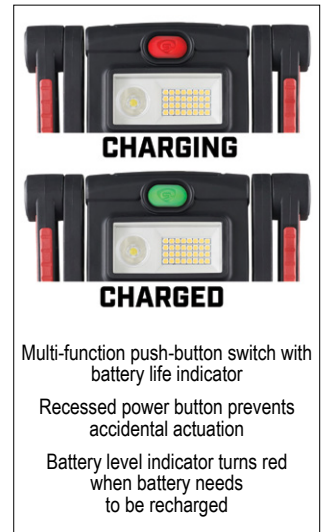

ITEM #	DESCRIPTION
61523	BearTrap 360 - 120V/100V AC
44922	120V AC Cord
44923	12V DC Cord
61522	Lithium-ion Battery



SCENE LIGHT/LANTERN SERIES //

SCENE LIGHTING SPECIALISTS

FROM FIRST ON THE SCENE TO THE LAST ONE OUT
OF THE TUNNEL, HEROES TRUST STREAMLIGHT.

Lanterns are part of our history and part of our future. In 1973, Streamlight pioneered portable lighting with our million candlepower Streamlite 1 Million™ and for the past 50 years we continue to forge new ways to provide light where it's needed.



VULCAN® 180



WAYPOINT® 400



THE SIEGE®

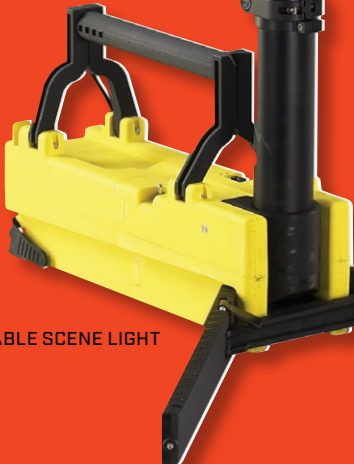

PORTABLE SCENE LIGHT



VULCAN CLUTCH®



PORTABLE SCENE LIGHT II

LIGHT UP THE WORLD ANYWHERE YOU WANT

PORTABLE SCENE LIGHT PORTABLE SCENE LIGHT EXT

The Portable Scene Light provides rapid deployment on site, and it goes anywhere. With its 90° swivel neck, it's easy to shine light into the most out-of-the-way place. The head extends to 72" within seconds. It provides 3 levels of lighting and substantial run time to last through several shifts, even days. The unique diffuser lets you select a flood or spot beam in all three levels. It's designed to adapt to tight spaces, but rugged enough to be stable in wide open terrain or steps. The regulated light provides consistent output throughout the life of the battery. It's an indispensable tool for first responders, construction crews, and utility workers.

PORTABLE SCENE LIGHT

BATTERY: Zero-maintenance, sealed lead acid
Can also be powered by 12V DC power cord
SIZE: 22.5" x 6.7" x 11" (55.88 x 17 x 27.9 cm)
WEIGHT: 25 lbs. (11.3kg)
COLOR: Yellow

PORTABLE SCENE LIGHT EXT

BATTERY: Zero-maintenance, sealed lead acid
Can also be powered by 12V DC power cord
SIZE: 25.5" x 6.7" x 11" (64.8 x 17 x 27.9 cm)
WEIGHT: 25.5 lbs. (11.6kg)
COLOR: Yellow

	HIGH	MEDIUM	LOW
LUMENS:	5,300	2,500	1,300
CANDELA:	42,000	21,300	11,800
DISTANCE:	410m	292m	215m
RUN TIME:	4h	9h	18h



ITEM #	DESCRIPTION
45670	Portable Scene Light - 120V AC/12V DC
45680	Portable Scene Light EXT - 120V AC/12V DC



Special Features:

- Full deployment in 30 seconds
- Designed to resist 40mph wind continuous in all directions with head fully extended
- Unlimited run time using AC/DC power source
- IP67-rated; dust-tight and **WATERPROOF TO 1M FOR 30 MINUTES**
- Stabilization legs provide balance on uneven surfaces

STREAMLIGHT SCENE LIGHT SERIES

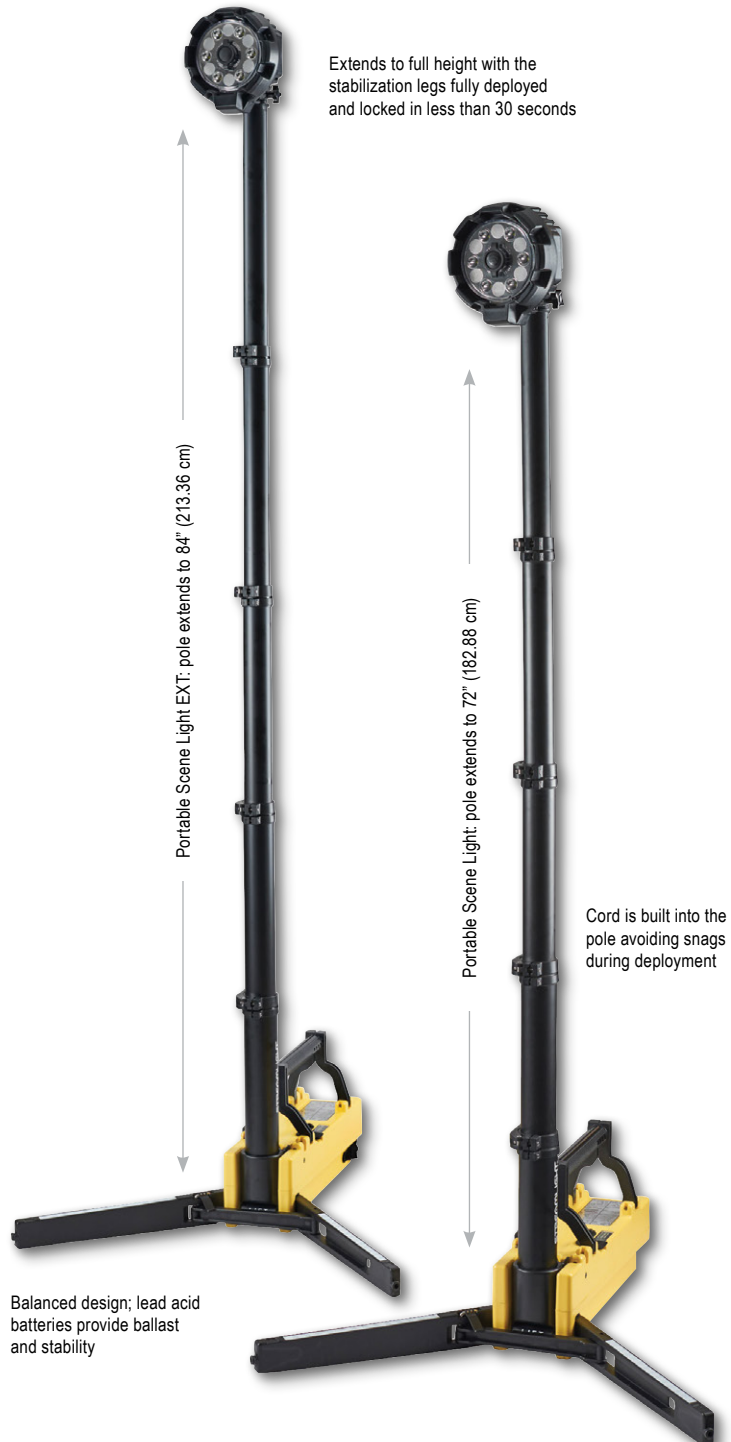

PORTABLE SCENE LIGHT II : TURN TO A HIGHER POWER

- STACKABLE FOR “LIGHT TOWER” CAPABILITY
- 360-DEGREE ROTATING HEAD
- PORTABLE, CORDLESS AND LIGHTWEIGHT
- HIGH-QUALITY, VIRTUALLY INDESTRUCTIBLE ALLOY STEEL FRAME
- WATERPROOF
- 10,000 LUMENS

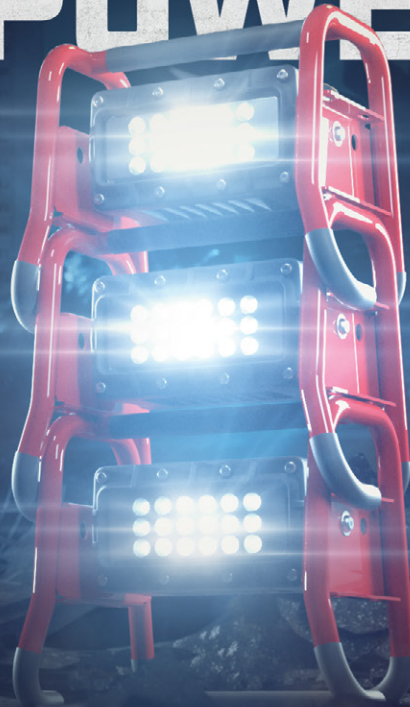

PORTABLE SCENE LIGHT II

Turn to a higher power with the Portable Scene Light II. 18 LEDs produce 10,000 lumens to light up the entire scene. With zero deployment time, it features a compact footprint, 360° rotating head and it's stackable for “light tower” capability with multi-level lighting. High-impact thermoplastic housing mounted in a virtually indestructible alloy steel frame. Hooked feet for hanging over doors, guard rails, fences, etc. The perfect scene light for marking exits, post fire investigation, fire ground clean-up, mobile triage center lighting, etc.

BATTERY: Lithium-ion Rechargeable
SIZE: 16" x 11" x 12" (40.6 x 27.9 x 30.5 cm)
WEIGHT: 15.56 lbs. (7.03 kg)
COLOR: Red



ITEM #	DESCRIPTION
46000	Portable Scene Light II - 120V AC/12V DC

	100%	80%	60%	40%	20%
LUMENS:	10,000	8,300	6,300	4,500	2,300
RUN TIME:	2h	2.75h	3.75h	5.75h	11h

Digital display shows intensity level and run time



Toggle switch - choose from 5 intensity levels

Special Features:

- Portable, cordless, ultra compact
- Virtually indestructible alloy steel frame
- Unlimited run time using AC/DC power source
 - Batteries will continue to charge while in use
- IPX7 WATERPROOF TO 1M FOR 30 MINUTES

Use a single unit or stack for multi-level lighting



Hang over doors, guard rails, fences, etc.



CORDLESS AND COMPACT PREVENTS TRIP HAZARDS

The Portable Scene Light II makes your work site safer and clean up easier. It's cordless and compact so it removes trip hazards and is easy to maneuver around. Stackable for "light tower" capability, individual units feature a 360° rotating head to aim the beam for multi-level lighting. Lightweight - under 16 lbs - so if you need to grab one off the stack and move to another location, it won't weigh you down.

TAKE YOUR WORK SITE FROM THIS:



TO THIS:





SEE AND BE SEEN EVEN IN THE THICKEST SMOKE

THE VULCAN SERIES FEATURES A TIGHT BEAM AND
BLUE TAILLIGHT LEDS

VULCAN® 180

The lightest portable lantern of its kind, the Vulcan 180 is designed to burn brighter and run longer making it an essential firefighting tool. This rechargeable, waterproof lantern has a 180° tilting head which allows you to direct the light where you need it. Three LEDs bring you extreme brightness along with two blue taillight LEDs for visibility in thick smoke. IP64 rated, dust-tight and water resistant; 2m impact resistance tested.

BATTERY: Lithium-ion Rechargeable
SIZE: 7.43" x 4.32" x 4.36" (18.8 x 10.9 x 11 cm)
WEIGHT: 2.47 lbs. (1.12 kg)
COLOR: Orange or Yellow

YELLOW	ORANGE	DESCRIPTION
44307	44311	Vulcan 180 - Standard System - 120V AC/12V DC, quick release shoulder strap
44301	---	Vulcan 180 - Standard System - 120V AC/12V DC, heavy duty shoulder strap
44305	44315	Vulcan 180 - Vehicle Mount System - 12V DC, shoulder strap
44300	44310	Vulcan 180 - Without Charger



Class I, Div 2, Grps. A, B, C, D;
 Class II, Div 2, Grps. F, G;
 Class III; T-Class: T4



Rack meets the requirement
 of NFPA 1900-11.1.11.2 (2024)
 mounted in any position.

Large, multi-function, push button switch
 easy to use with gloved hands.



**1,200
LUMENS**

NFPA

Rack meets the requirement
 of NFPA 1900-11.1.11.2 (2024)
 mounted in any position.

	HIGH	LOW
LUMENS:	1,200	350
CANDELA:	75,000	22,000
DISTANCE:	548m	296m
RUN TIME:	5.75h	16h

Flat base area allows light to stand
 on its own for scene lighting.



Taillight LEDs ensure you can be
 seen even from behind.
 Can be programmed on or off

	HIGH	LOW
LUMENS:	400	130
CANDELA:	25,000	8,000
DISTANCE:	316m	179m
RUN TIME:	10h	24h



Class I, II, III, Div 1,
Grps. A, B, C, D, E, F, G
Class I, Zone 0, Group IIC,
Class III, T-Code: T4

NFPA

Rack meets the requirement
of NFPA 1900-11.1.11.2 (2024)
mounted in any position.

BATTERY: Lithium-ion Rechargeable
SIZE: 7.43" x 4.32" x 4.36" (18.8 x 10.9 x 11 cm)
WEIGHT: 2.47 lbs. (1.12 kg)
COLOR: Orange or Yellow

YELLOW	ORANGE	DESCRIPTION
44321	44331	Vulcan 180 HAZ-LO - Standard System - 120V AC/12V DC, Includes quick release shoulder strap
44325	44335	Vulcan 180 HAZ-LO - Vehicle Mount System - 12V DC, Includes quick release shoulder strap
44320	44330	Vulcan 180 HAZ-LO - Without Charger

VULCAN® 180 HAZ-LO®

Developed for use in hazardous locations on a portable scene light platform the Class 1, Div. 1 safety rated Vulcan 180 is lightweight and rechargeable. Combine the three extreme bright white LEDs with cordless operation to eliminate trip hazards while two ultra-bright blue taillights provide visibility in thick smoke. Use its 180° articulating head to target the light where needed. A large handle enables smooth handoffs even with gloves. IP65 rated; dust-tight and water resistant; 2m impact resistance tested.

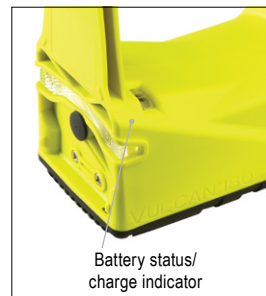
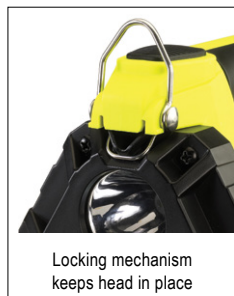

STREAMLIGHT
VULCAN SERIES



VULCAN CLUTCH®

The Vulcan Clutch, with its downward-angled head is designed to illuminate your path so you can navigate to your destination safely and efficiently. Once on-site, clamp it virtually anywhere and articulate the head to direct the beam where you need it. Flash mode for use as an exit marker or warning beacon.

Three white LEDs produce extreme brightness and two ultra-bright blue taillight LEDs provide visibility in thick smoke. A large handle enables smooth handoffs even with gloves. IPX7-rated; waterproof to 1m for 30 minutes. Uses the same mounting rack as the Vulcan 180.

	HIGH	LOW
LUMENS:	1,700	380
CANDELA:	67,500	15,000
DISTANCE:	520m	245m
RUN TIME:	6.5h	18h
FLASH RUNS 25 HOURS		



BATTERY: Lithium-ion Rechargeable
SIZE: 9.39" x 4.6" x 6.4" (23.85 x 11.68 x 16.26 cm)
WEIGHT: 2.84 lbs (1288g)
COLOR: Orange or Yellow

NFPA

Rack meets the requirement of NFPA 1900-11.1.11.2 [2024] mounted in any position.

Large, multi-function, push button switch easy to use with gloved hands



Orange model includes quick release shoulder strap.



Yellow model includes heavy duty shoulder strap.

ITEM #	DESCRIPTION
44361	Vulcan Clutch - 120V/100V AC/12V DC - Includes quick release shoulder strap - Orange
44365	Vulcan Clutch - Vehicle Mount System - 12V DC - Includes quick release shoulder strap - Orange
44360	Vulcan Clutch - Light Only - Includes quick release shoulder strap - Orange
44371	Vulcan Clutch - 120V/100V AC/12V DC - Includes heavy duty shoulder strap - Yellow
44375	Vulcan Clutch - Vehicle Mount System - 12V DC - Includes heavy duty shoulder strap - Yellow
44370	Vulcan Clutch - Light Only - Includes heavy duty shoulder strap - Yellow

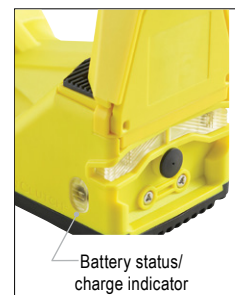

STREAMLIGHT LANTERN SERIES

E-FLOOD® LITEBOX® // E-FLOOD® FIREBOX® **NEW**

The E-Flood series produces diffused light over an entire area using four LEDs within shallow reflectors for a widened beam pattern; an articulating head allows you to aim light right where it is needed. Its large push-button switch is easy to use with heavy gloves and features a battery status indicator. A large grip area makes for easy hand-offs. Includes heavy duty shoulder strap.

ORANGE	YELLOW	DESCRIPTION
E-FLOOD LITEBOX		
45801	45821	E-Flood LiteBox - 120V AC/12V DC - Includes shoulder strap & mounting rack
45805	45825	E-Flood LiteBox Vehicle Mount System - 12V DC - Includes shoulder strap
45807	--	E-Flood LiteBox Power Failure System - 120V AC/12V DC - Includes mounting rack <i>Features "Smart" power failure circuitry which automatically illuminates the light when the power is lost.</i>
45806	45826	E-Flood LiteBox (Without Charger)
E-FLOOD FIREBOX [DUAL REAR LEDS]		
45811	--	E-Flood FireBox - 120V AC/12V DC - Includes shoulder strap & mounting rack
45815	--	E-Flood FireBox - Vehicle Mount System - 12V DC - Includes shoulder strap
45832	--	E-Flood FireBox (Without Charger)

BATTERY: Zero-maintenance sealed lead acid
SIZE: 11.2 in. (28.4 cm)
WEIGHT: 3.1 lbs. (1389g)
COLOR: Orange or Yellow

	HIGH	LOW
LUMENS:	1,500	350
CANDELA:	4,700	1,000
DISTANCE:	137m	63m
RUN TIME:	7.5h	17.75h



NFPA Charging rack meets requirements of NFPA 1900-11.1.11.2 (2024) mounted in any position

E-SPOT® LITEBOX® // E-SPOT® FIREBOX® **NEW**

E-Spot series produces a long range, focused beam pattern using four LEDs within deep parabolic reflectors to spotlight an area with focused bright light. It features a swivel head that makes it easy to inspect high bays, ceilings, and out-of-the-way places. Its large push-button switch is easy to use with heavy gloves and features a battery status indicator. A large grip area makes for easy hand-offs. Includes heavy duty shoulder strap.

ORANGE	YELLOW	DESCRIPTION
E-SPOT LITEBOX		
45851	45871	E-Spot LiteBox - 120V AC/12V DC - Includes shoulder strap & mounting rack
45855	45875	E-Spot LiteBox - Vehicle Mount System - 12V DC - Includes shoulder strap
45857	---	E-Spot LiteBox Power Failure System - 120V AC/12V DC - Includes mounting rack <i>Features "Smart" power failure circuitry which automatically illuminates the light when the power is lost.</i>
45856	45866	E-Spot LiteBox (Without Charger)
E-SPOT FIREBOX [DUAL REAR LEDS]		
45861	--	E-Flood FireBox - 120V AC/12V DC - Includes shoulder strap & mounting rack
45865	--	E-Flood FireBox - Vehicle Mount System - 12V DC - Includes shoulder strap
45882	--	E-Flood FireBox (Without Charger)

BATTERY: Zero-maintenance sealed lead acid
SIZE: 11.2 in. (28.4 cm)
WEIGHT: 3.1 lbs. (1389g)
COLOR: Orange or Yellow

	HIGH	LOW
LUMENS:	1,500	350
CANDELA:	110,000	25,000
DISTANCE:	663m	316m
RUN TIME:	7.5h	17.75h



NFPA Charging rack meets requirements of NFPA 1900-11.1.11.2 (2024) mounted in any position



Special Features:

- Flat side allows light to tilt and stand on its own
- Multi-function, push button switch with battery status indicator
- Dual rear LEDs *FIREBOXES ONLY*
- IPX4-rated; water-resistant; 1m impact resistance tested
- Recharges in 5 hours



FIRE VULCAN® LED

This lightweight lantern features two ultra-bright blue taillight LEDs that help you be seen even in thick smoke. It is IPX7-rated; waterproof to 1m for 30 minutes, and it floats! Programmable light functions let you control the order in which the modes come on. Other features include an unbreakable, scratch-resistant, O-ring sealed lens and a quick-release shoulder strap.

BATTERY: Lithium-ion Rechargeable
SIZE: 7.5" x 5" x 6.5" (19.05 x 12.7 x 16.51 cm)
WEIGHT: 1.85 lbs. (839g)
COLOR: Orange

	HIGH	LOW
LUMENS:	180	80
CANDELA:	100,000	45,000
RUN TIME:	5h	10h



Ultra-bright blue tail light LEDs make certain you can be seen, even in thick smoke.



Class I, Div. 2, Grps. A, B, C, D;
 Class II, Div. 2, Grps. F, G;
 Class III, T-Code: T4

NFPA

Rack meets the requirement of NFPA 1900-11.1.1.2 (2024) mounted in any position.

ITEM #	DESCRIPTION
44450	Fire Vulcan LED - Standard System - 120V/100V AC/12V DC - Includes quick release shoulder strap & rack
44451	Fire Vulcan LED - Vehicle Mount System - 12V DC - Includes direct wire rack, shoulder strap
44454	Fire Vulcan LED (Without Charger) - Includes quick release shoulder strap



STREAMLIGHT LANTERN SERIES



HID LITEBOX®

This portable, one million candela searchlight illuminates objects up to a mile away. Its 35-watt, high intensity xenon lamp has a 2,000-hour minimum lifetime and a 90° swivel head. The intense brightness and amazing 1-mile reach make this the ideal hand-held light when you absolutely must be able to inspect an entire area quickly and efficiently. It plugs into your vehicle's power source for an unlimited run time.

- BATTERY:** Zero-maintenance, sealed lead acid
- SIZE:** 14.9" x 5.1" x 8.8" (38 x 13 x 23 cm)
- WEIGHT:** 10 lbs. 1.6 oz. (4.6 kg)
- COLOR:** Orange or Black

ORANGE	BLACK	DESCRIPTION
45601	45621	HID LiteBox - Std System - 120V AC/12V DC - Includes 10 ft (3m) 12V DC cord, shoulder strap and flood lens
45605	45625	HID LiteBox - Vehicle Mount System - 12V DC direct wire rack - Includes 10ft (3m) 12V DC cord, shoulder strap and flood lens
45600	45620	HID LiteBox - Light Only - Includes 10 ft (3m) 12V DC cord, shoulder strap and flood lens



1,000,000 cd



10 ft (3 meters) 12V DC power cord plugs into port at rear of light to provide duration lighting

HID LiteBox battery will continue to charge while operating directly from an external 12V DC power source when using the remote cord



LUMENS:	3,350
CANDELA:	1,00,000
RUN TIME:	1.75h

NFPA

Rack meets the requirement of NFPA 1900-11.1.11.2 (2024) mounted in any position.

ACCESSORIES

DESCRIPTION	PART #	GOES WITH
Standard Mounting Rack—Orange Vehicle Mounting Rack—Orange Vehicle Mounting Rack—Yellow	45070 45071 45074	E-Flood LiteBox/FireBox, E-Spot LiteBox/FireBox, HID LiteBox
Standard Mounting Rack—Black Vehicle Mounting Rack—Black	45075 45076	HID LiteBox
Standard Charge Rack - Black Vehicle Mounting Rack - Black	44103 44132	Fire Vulcan LED
Standard Charge Rack - Black Direct Wire 12V DC Charge Rack Kit - Black	44350 44306	Vulcan 180, Vulcan Clutch
12V DC (Car Socket) Charge Cord	22051	E-Flood LiteBox/FireBox, E-Spot LiteBox/FireBox, HID LiteBox, Fire Vulcan LED, Vulcan 180, Vulcan Clutch
12V DC Charge Cord	22050	E-Flood LiteBox/FireBox, E-Spot LiteBox/FireBox, HID LiteBox, Fire Vulcan LED, Vulcan 180, Vulcan Clutch
12V DC Charge Cord (10 ft/3m)	22056	Portable Scene Light, Portable Scene Light EXT, Portable Scene Light II, HID LiteBox
120V AC Charge Cord	22060	E-Flood LiteBox/FireBox, E-Spot LiteBox/FireBox, Fire Vulcan LED, Vulcan 180, Vulcan Clutch
120V AC Charge Cord	22085	HID LiteBox
Power Supply 120V AC Charge Cord	22083 22074	Portable Scene Light, Portable Scene Light EXT, Portable Scene Light II
Battery (Sealed Lead Acid)	45630	Portable Scene Light, Portable Scene Light EXT, HID LiteBox
Battery (Sealed Lead Acid)	45937	E-Flood LiteBox, E-Spot LiteBox - (Original version)
Battery (Lithium-ion)	45938	E-Flood LiteBox/FireBox, E-Spot LiteBox/FireBox (Upgraded version)
Battery (Lithium-ion)	44610	Fire Vulcan LED
Battery (Lithium-ion)	44351	Vulcan 180
Battery (Lithium-ion)	44352	Vulcan 180 HAZ-LO
Battery (Lithium-ion)	44366	Vulcan Clutch
Battery (Lithium-ion)	46005	Portable Scene Light II
HID Bulb Kit	45637	HID LiteBox
Flood Lens	45657	HID LiteBox
IR Filter	45654	HID LiteBox
E-Spot Upgrade Kit E-Flood Upgrade Kit	45845 45842	E-Spot LiteBox/FireBox (Original version)
Quick Release Strap	44050	E-Flood LiteBox, E-Flood LiteBox/FireBox, E-Spot LiteBox/FireBox, HID LiteBox, Fire Vulcan LED, Vulcan 180, Vulcan Clutch
Heavy Duty Strap	45232	E-Flood LiteBox, E-Flood LiteBox/FireBox, E-Spot LiteBox/FireBox, HID LiteBox, Fire Vulcan LED, Vulcan 180, Vulcan Clutch
Heavy Duty Strap with Carabiner Lock	45677	Portable Scene Light, Portable Scene Light EXT

WAYPOINT®

	HIGH	LOW
LUMENS:	550	40
CANDELA:	100,000	7,900
DISTANCE:	625m	178m
RUN TIME:	10h	82h

12V DC POWER CORD - UNLIMITED RUN TIME
EMERGENCY SIGNAL: RUNS 82 HOURS



Trigger style switch with momentary operation



Integrated stand for hands-free lighting

Use the ultra-bright, long-distance beam of the Waypoint as a spotlight to illuminate far-off objects. This pistol grip light has a trigger-style switch, as well as an integrated stand so that you can set it down for hands-free lighting. It's the perfect tool for inspections or looking for addresses or any other objects you can't get close to easily. IPX4-rated; water-resistant.

BATTERY: 4 "C" batteries (not included).
Can also be powered by 12V DC power cord (included)
SIZE: 6.75" x 7.14" x 3.5" (17.15 x 18.14 x 8.89 cm)
WEIGHT: 1.8 lbs. (816g)
COLOR: Yellow or Black



12V DC power cord for unlimited run time (does not charge batteries)



Polymer storage mount (included)



Includes 120V AC Charge Cord



Optional 12V DC Charge Cord



Polymer storage mount (included)

Green Filter reduces shadows



Red Filter preserves night vision

Green Filter reduces shadows



Red Filter preserves night vision

ITEM #	DESCRIPTION
44900	Waypoint - Includes 12V DC power cord - Box - Yellow
44902	Waypoint - Includes 12V DC power cord - Box - Black
44904	Waypoint - Includes 12V DC power cord - Clam - Yellow
44905	Waypoint - Includes 12V DC power cord - Clam - Black
44908	Polymer Storage Mount
44903	12V DC Power Cord*
44924	Red Filter
44925	Green Filter

*12V DC power cord does not charge batteries

WAYPOINT® 400

	HIGH	MEDIUM	LOW
LUMENS:	1,400	600	38
CANDELA:	400,000	165,000	10,000
DISTANCE:	1,265m	812m	200m
RUN TIME:	3.25h	7.5h	84h



400,000 cd



1,265m



The rechargeable Waypoint 400 produces a far-reaching beam that reaches into corners and illuminates high ceilings and other out-of-reach places. IPX8-rated; waterproof to 2m and it floats. High, medium and low modes provide the right amount of light and run time needed to complete your task. An integrated stand for hands-free area lighting. Recharges in 4 hours.

BATTERY: Lithium-ion with on-board safety control circuit
SIZE: 6.75" x 7.14" x 3.62" (17.15 x 18.14 x 9.29 cm)
WEIGHT: 1.52 lbs. (691g)
COLOR: Yellow or Black

ITEM #	DESCRIPTION
44910	Waypoint 400 - 120V AC - Box - Yellow
44911	Waypoint 400 - 120V AC - Box - Black
44901	Polymer Storage Mount
44909	120V AC Charge Cord
44923	12V DC Cord
44915	Red Filter
44916	Green Filter



STREAMLIGHT
SIEGE SERIES



SUPER SIEGE **THE HARDEST**
WORKING
SIEGE LANTERN

SUPER SIEGE®

The Super Siege rechargeable scene light/work lantern provides 360° of bright light that illuminates an entire scene. A rechargeable lithium-ion battery supplies the power to charge your Streamlight flashlights, smartphones and tablets. Remove the globe cover and hang the Super Siege upside down by its D-ring for large area lighting needs. Use the Glare Guard™ to shield light from 1/2 the globe for up-close task lighting. Set it to SOS mode for emergency situations. Working in a grueling environment? No problem! Its rubber base keeps it stable on slippery or uneven surfaces, and a watertight storage compartment keeps small items dry. IPX7-rated; waterproof to 1m. It floats.

BATTERY: Lithium-ion
SIZE: 3.8" x 7.5" (9.65 x 19.05 cm)
WEIGHT: 1 lb. 14 oz. (867.62g)
COLOR: Coyote or Yellow



Magnetic
Accessory Base

ITEM #	DESCRIPTION
44947	Super Siege - 120V AC - Coyote
44945	Super Siege - 120V AC - Yellow
44909	120V AC Charge Cord
44950	Glare Guard™
44951	Magnetic Base - Black

WHITE	HIGH	MEDIUM	LOW
LUMENS:	1,100	550	125
RUN TIME:	5.75h	11.5h	36.25h
RED	HIGH	SOS	LOW
LUMENS:	2.7	2.7	1
RUN TIME:	140h	320h	348h

[(RED SOS)]

Hold on/off button
to activate



**1,100
LUMENS**



Rechargeable lithium-ion battery supplies the power for the lantern as well as enabling you to recharge all your electronic devices from the handy USB port.



A small dry storage area is provided in the light's base for all your "keep dry" needs



STREAMLIGHT
SIEGE SERIES



THE SIEGE®

The Siege is brighter, more durable, and much more versatile than other emergency/camping lanterns. It's bright enough to light up a whole campsite. It runs for over 30 hours on high and over 12 days on low! Its handle and D-rings allow you to hang it or clip it almost anywhere, upright or inverted. It has 3 white light settings, a red light for softer, less intense light, and an SOS mode. Remove the top for brighter light. Battery indicator flashes to alert you to low battery. Waterproof to 1m; it floats.

BATTERY: (3) "D" alkaline
SIZE: 3.8" x 7.25" (9.65 x 18.41 cm)
WEIGHT: 1 lb. 15 oz. (878g)
COLOR: Coyote

ITEM #	DESCRIPTION
44931	The Siege
44950	Glare Guard™
44952	Magnetic Base - Black

Magnetic
Accessory Base



Shown with
outer globe
removed.



SIEGE® AA

The Siege AA lantern features white LED and red LEDs for scene lighting, low level lighting or SOS mode. There are five output modes and a battery level indicator built into the power button. With the outer lantern globe in place, the Siege AA will float. Remove the outer globe and hang the body upside down by the D-ring for large area lighting needs. Battery replacement is a breeze with the center post orienting the battery cover correctly every time.

BATTERY: (3) "AA" alkaline
SIZE: 2.37" x 5.44" (6 x 13.82 cm)
WEIGHT: 8.8 oz. (249.47g) // 9.1 oz. (257.98g) w/ Magnet
COLOR: Coyote or Yellow

ITEM #	DESCRIPTION
44941	Siege AA - Coyote
44943	Siege AA - Yellow with magnetic base
44942	Magnetic Base - Coyote

WHITE	HIGH	MEDIUM	LOW
LUMENS:	540	275	55
RUN TIME:	30h	70h	295h
RED	HIGH	SOS	
LUMENS:	10	10	
RUN TIME:	235h	430h	

[(RED SOS)]

Hold on/off button
to activate



WHITE	HIGH	MEDIUM	LOW
LUMENS:	200	100	50
RUN TIME:	7h	15.5h	37h
RED	HIGH	SOS	
LUMENS:	.7	.7	
RUN TIME:	192h	288h	

[(RED SOS)]

Hold on/off button
to activate



The yellow Siege AA has three strong magnets in the base. It's now a versatile, hands-free work light that can be attached to steel surfaces like engines, machines, or other equipment.



Optional magnetic base for
hands-free work.

SURVIVOR/VANTAGE SERIES //

RIGHT-ANGLE LIGHTING

WHETHER IT'S ON THE BODY OR ON THE HELMET,
STREAMLIGHT DELIVERS THE TRUSTED OPTIONS.

Ask any firefighter what light they trust most... and the likely answer is the Streamlight Survivor. And while we're proud of that fact, we're also not one to let it rest at that. We continue to develop products that keep firefighters and industrial workers safe. Because as we all know, the work is never truly done.



VANTAGE®
180 X USB



VANTAGE® II



SURVIVOR PIVOT®



SURVIVOR® X

SURVIVOR® X USB

The Survivor X USB provides budget-friendly rechargeability combined with added features and increased output. Uses an SL-B26® battery pack that is easily interchangeable with alkaline batteries as a backup on-scene. IP67-rated; dust-tight and waterproof to 1m for 30 minutes; 2m impact resistance tested. Lightweight design because we understand that when carrying a lot of gear, every ounce counts. Class I, Div. 2 safety-rated.



	HIGH	LOW
LUMENS:	250	60
CANDELA:	50,000	14,000
DISTANCE:	447m	237m
RUN TIME (SL-B26):	4h	15h
RUN TIME (ALK):	5h	15h
FLASH RUNS 8 HOURS		

BATTERY: USB rechargeable SL-B26 battery pack; also accepts (3) "AA" alkaline
SIZE: 7.06" x 2.85" x 2.32" (17.9 x 7.24 x 5.89 cm)
WEIGHT: Alkaline - 12.8 oz. (363g) // SL-B26 - 11.9 oz. (337g)
COLOR: Orange or Yellow

ORANGE	YELLOW	DESCRIPTION
90044	90244	Survivor X USB - Includes SL-B26 Battery Pack



Class I, II, Div. 2,
Grps. A, B, C, D, E, F, G;
Class III, T-Code: T4

NFPA

Flashlight meets 500°F
requirements of NFPA
1971-8.6 (2018)

NFPA

Charger meets requirements of
NFPA 1900-11.11.2 (2024)
mounted in any position

SURVIVOR® X

The Survivor X provides added features and increased output. Uses lithium-ion battery pack that is easily interchangeable with alkaline batteries as a backup on-scene. IP67-rated; dust-tight and waterproof to 1m for 30 minutes; 2m impact resistance tested. Lightweight design because we understand that when carrying a lot of gear, every ounce counts. Class I, Div. 1 safety-rated.

Note: The Survivor X is not compatible with legacy Survivor chargers.

	HIGH	LOW
LUMENS:	250	60
CANDELA:	50,000	14,000
DISTANCE:	447m	237m
RUN TIME (LI-ION):	3.75h	15h
RUN TIME (ALK):	5h	15h
FLASH RUNS 8 HOURS		

BATTERY: USB rechargeable lithium-ion battery pack; also accepts (3) "AA" alkaline
SIZE: 7.06" x 2.85" x 2.32" (17.9 x 7.24 x 5.89 cm)
WEIGHT: Alkaline - 12.8 oz. (363g) // Li-ion - 12.2 oz. (346g)
COLOR: Orange or Yellow

ORANGE	YELLOW	DESCRIPTION
90952	90962	Survivor X - 120V/100V AC/12V DC
90950	90960	Survivor X - Alkaline
90951	90961	Survivor X - Light Only



Class I, II, Div. 1,
Grps. A, B, C, D, E, F, G;
Class III, T-Code: T3/T4

NFPA

Flashlight meets 500°F
requirements of NFPA
1971 8.6 (2018)

NFPA

Charger meets requirements of
NFPA 1900-11.11.2 (2024)
mounted in any position



Strong spring-loaded clip
securely grabs onto belts and
gear; D-ring provides forward
hanging orientation



Battery life indicator in switch:

- Green indicates full charge
- Turns red when battery is nearing low voltage
- Flashes red continuously when 15 minutes left of battery

SURVIVOR® X IMPROVED CHARGER DESIGN

Improved charger design:

- Survivor X securely locks into the charger - fits snugly in place
- Quick release latch for one-handed grab-and-go
- Easy to remove with gloved hands
- Charge indicator shines solid red when charging and solid green when charged



Note: The Survivor X is not compatible with legacy Survivor chargers; however, the new charger WILL charge both Streamlight's Legacy Survivors as well as the new Survivor X.



- Know your charge status with battery life indicator in switch boot
- Green indicates full charge
- Turns red when battery is nearing end of usable charge
- Flashes red continuously with 15 minutes or less remaining of battery life

STREAMLIGHT
SURVIVOR SERIES



INTRODUCING THE



DUAL BEAM, 90-DEGREE ARTICULATING HEAD

SURVIVOR PIVOT® AND SURVIVOR PIVOT® USB



SURVIVOR PIVOT® USB **NEW**

The multi-function Survivor Pivot USB provides budget-friendly rechargeability combined with a dual-beam and 90-degree articulating head. Its spot beam uses a cool white, high-power LED for maximum distance illumination and its flood beam is angled downward for area illumination. It uses an SL-B26® battery pack that is easily interchangeable with alkaline batteries as a backup on-scene. IP67-rated; dust-tight and waterproof to 1m for 30 minutes; 2m impact resistance tested. Class I, Div. 2 safety-rated.



NFPA
Charger meets requirements of NFPA 1900-11.1.11.2 (2024) mounted in any position

NFPA
Flashlight meets 500°F requirements of NFPA 1971-8.6 (2018)



Class I, II, Div. 2,
Grps. A, B, C, D, F, G;
Class III, T-Code: T4

SURVIVOR PIVOT® **NEW**

The multi-function, Survivor Pivot features a dual-beam and 90-degree articulating head. Its spot beam uses a cool white, high-power LED for maximum distance illumination and its flood beam is angled downward for area illumination. Uses lithium-ion battery pack that is easily interchangeable with alkaline batteries as a backup on-scene. IP67-rated; dust-tight and waterproof to 1m for 30 minutes; 2m impact resistance tested.



NFPA
Charging rack meets requirements of NFPA 1900-11.1.11.2 (2024) mounted in any position

NFPA
Flashlight meets 500°F requirements of NFPA 1971-8.6 (2018)



Class I, II, Div. 1,
Grps. A, B, C, D, E, F, G;
Class III, T-Code: T3/T4

	COMBO		SPOT		FLOOD	
	HIGH	LOW	HIGH	LOW	HIGH	LOW
LUMENS:	325	80	300	70	300	70
CANDELA:	19,000	5,000	34,000	8,500	300	75
DISTANCE:	267m	141m	369m	184m	35m	17m
RUN TIME (ALK):	4.5h	12h	5.5h	15h	5.5h	15h
RUN TIME (LI-ION/SL-B26):	3.75h	13h	4.25h	16h	4.25h	16h



- Battery status indicator in switch:
- Green when fully charged
 - Red when low voltage
 - Flashes red with 15 minutes left on battery



**USB
MULTI-FUEL
FLEXIBILITY**

POWER UP WITH A STREAMLIGHT SL-B26 PROTECTED LI-ION USB RECHARGEABLE BATTERY PACK, LITHIUM LI-ION BATTERY OR (3) AA ALKALINE BATTERIES

Strong spring-loaded clip securely grabs onto jackets and gear; D-ring provides forward hanging orientation



Optional magnet

SURVIVOR PIVOT USB

- BATTERY:** SL-B26 rechargeable battery pack; also accepts (3) AA alkaline
SIZE: 7.93" x 2.86" x 3.29" (20.1 x 7.26 x 8.36 cm)
SIZE W/MAGNET: 7.93" x 2.86" x 3.64" (20.1 x 7.26 x 9.25 cm)
WEIGHT: Alkaline - 16.7 oz. (473g) // SL-B26 - 15.8 oz. (448g)
WEIGHT W/MAGNET: Alkaline - 18.1 oz. (513g) // SL-B26 - 17.2 oz. (488g)
COLOR: Orange or Yellow

ORANGE w/o MAGNET	YELLOW w/o MAGNET	ORANGE w/ MAGNET	YELLOW w/ MAGNET	DESCRIPTION
91804	91814	91838	91839	Survivor Pivot USB - C1D2

SURVIVOR PIVOT

- BATTERY:** Lithium-ion rechargeable battery pack; also accepts (3) AA alkaline
SIZE: 7.93" x 2.86" x 3.29" (20.1 x 7.26 x 8.36 cm)
SIZE : 7.93" x 2.86" x 3.64" (20.1 x 7.26 x 9.25 cm)
WEIGHT: Alkaline - 16.7 oz. (473g) // Li-Ion - 16.2 oz. (459g)
WEIGHT W/MAGNET: Alkaline - 18.1 oz. (513g) // Li-Ion - 17.6 oz. (499g)
COLOR: Orange or Yellow

ORANGE w/o MAGNET	YELLOW w/o MAGNET	ORANGE w/ MAGNET	YELLOW w/ MAGNET	DESCRIPTION
91802	91812	91830	91831	Survivor Pivot - 120V AC/12V DC
91800	91810	91825	91826	Survivor Pivot - Alkaline - C1D1

Note: The Survivor Pivot® is not compatible with legacy Survivor® chargers.



THE MOST TRUSTED RIGHT ANGLE LIGHT
THIN, BRIGHT &
EXTREMELY
VERSATILE
SURVIVOR



SURVIVOR®

This leading Class I, Div. 1 right angle flashlight features a slim profile, a D-ring for accurate light orientation and a spring-loaded clip that grabs onto your gear. Four lighting modes include high, low, flash, and moonlight (for low-level lighting to preserve batteries). IPX4-rated; water-resistant. Unbreakable, scratch-resistant polycarbonate lens. Push-button switch is designed for easy operation even with heavy gloves.

BATTERY: Rechargeable NiMH battery pack; also accepts (4) "AA" alkaline
SIZE: 7.06" (17.92 cm)
WEIGHT: Alkaline - 13.7 oz. (388g) // NiMH - 18 oz. (510g)
COLOR: Orange, Yellow or Black

ORANGE	YELLOW	BLACK	DESCRIPTION
90503	90513	90523	Survivor - 120V AC/12V DC
90500	90510	90520	Survivor - Without Charger
90540	90541	90545	Survivor - Alkaline

Interchangeable Smoke Cutter® plugs:



Black reduces peripheral light for a tighter beam



Amber reduces peripheral light and eye fatigue caused by glare



Low profile design

	HIGH	LOW
LUMENS:	175	60
CANDELA:	41,000	14,000
DISTANCE:	405m	237m
RUN TIME (RECH):	3.5h	13h
RUN TIME (ALK):	4h	15h
MOONLIGHT MODE: RUNS 20 DAYS FLASH RUNS 8 HOURS		



Class I, II, Div. 1, Grps. C, D, E, F, G;
Class I, Div. 2, Grps. A, B, C, D
Class III, T-Code: T4; T4

NFPA

Flashlight meets 500°F requirements of NFPA 1971-8.6 (2018)

NFPA

Charger meets requirements of NFPA 1900-11.1.11.2 (2024) mounted in any position



Permissible Flashlight, Approval No. 20-A150001-0 (Alkaline model)

SURVIVOR SERIES ACCESSORIES

DESCRIPTION	SURVIVOR	SURVIVOR X	SURVIVOR X USB	SURVIVOR PIVOT	SURVIVOR PIVOT USB
5 Unit 120V AC Bank Charger	90910	90910		90910	
5 Unit 12V DC Bank Charger	90912	90912		90912	
SL-B26 Bank Charger - 120V AC SL-B26 Bank Charger - 12V DC	---	20224 20223	20224 20223	20224 20223	20224 20223
Charger	90345	90345	---	90345	---
Lithium-ion Battery	---	90341	---	90341	---
NiMH Battery	90339	---	---	---	---
Alkaline/SL-B26 Battery Cartridge	---	90342	90342	90342	90342
Alkaline Battery Cartridge	90542	---	---	---	---
SL-B26 Battery Pack	---	---	22101 - 1pk 22105 - 8pk	---	22101 - 1pk 22105 - 8pk
12V DC1 Charge Cord	22051	22051	---	22051	---
12V DC2 Charge Cord	22050	22050	---	22050	---
120V AC Charge Cord	22060	22060	---	22060	---
40" (101.6 cm) Micro USB Cord 22" (55.88 cm) Micro USB Cord	---	22070 22081	22070 22081	22070 22081	22070 22081

Note: The Survivor X and Survivor Pivot are not compatible with legacy Survivor chargers.

STREAMLIGHT
VANTAGE SERIES

VANTAGE SERIES
THE VERSATILE SOLUTION
TO FIREFIGHTERS'
HANDS-FREE
LIGHTING NEEDS





VANTAGE® 180 X USB // VANTAGE® 180 X

This multi-fuel, multi-function light is the most versatile rechargeable firefighter's light. It's a helmet mounted light, right angle light and a hand-held flashlight. The Vantage 180 X USB is a rechargeable system that includes a Streamlight SL-B26 protected Li-Ion USB rechargeable battery pack with integrated USB port. The Vantage 180 X includes two CR123A batteries. Easily attaches above or below the brim of most helmets providing a bright main white LED and blue safety taillight. Quickly detaches for hand-held and clip-on right angle light with white taillight and downcast light to see what's at your feet. IPX7-rated; waterproof.

	HIGH	LOW
LUMENS:	250	100
CANDELA:	7,200	2,650
DISTANCE:	170m	103m
RUN TIME (CR123A):	4h	12h
RUN TIME (SL-B26):	5h	15h



Head articulates 180° to aim the beam.



Use as a helmet light. Easily attaches above or below brim. No tools necessary to quickly remove for use as a hand-held flashlight

BATTERY: (1) SL-B26 Li-Ion USB rechargeable battery pack or (2) CR123A lithium batteries
SIZE: 5.2" x 1.6" x 1.06" (13.2 x 4.06 x 2.69 cm)
WEIGHT: 5.9 oz. (167g) w/SL-B26 // 5.5 oz. (156g) w/CR123A
COLOR: Orange or Black

ORANGE	BLACK	DESCRIPTION
88911	88913	Vantage 180 X USB - Includes SL-B26 battery pack
88901	88903	Vantage 180 X - Includes CR123A lithium batteries



MULTI-FUEL DESIGN:
Runs on SL-B26 battery pack or CR123A batteries

NFPA

Meets requirements of NFPA 1971-8.6 (2018); 500° heat resistance test

Includes "quick release" helmet bracket and hex key.



Rear LED Taillight changes from blue to white:

- Blue LED for helmet mount use and visibility in heavy smoke
- White LED for a downcast flood light to see what's at your feet; switches from blue when head is at a 90° angle



STREAMLIGHT
VANTAGE SERIES



VANTAGE®

The solution to firefighters' hands-free lighting needs. Attaches easily to helmets and hard hats, and rotates 360°. Fits snugly against helmet to prevent snags. Includes a bright blue tail light so you can be seen from behind even in heavy smoke. Easy to operate with gloves. IPX7-rated; waterproof to 1 meter for 30 minutes. Fits both traditional and modern helmets.

BATTERY: (2) CR123A lithium
SIZE: 3.26" x 1.47" x 2.56" (8.28 x 3.73 x 6.5 cm)
WEIGHT: 5.14 oz. (145.7g)
COLOR: Black

NFPA
Meets requirements of
NFPA 1971-8.6 (2018);
500° heat resistance test

LUMENS:	115
CANDELA:	7,000
DISTANCE:	167m
RUN TIME:	6h



470nm ultra-bright
taillight LED.

Dual direction, easy access
on/off switch.

ITEM #	DESCRIPTION
69140	Vantage - Includes CR123A lithium batteries

VANTAGE® II

Lightweight, compact and low profile, the Vantage II is designed to easily attach above or below full brim Fire Helmets or Slotted Industrial Hard Hat mounts. The light features the latest in power LED technology combined with an ultra- bright blue LED safety taillight. Powered by a single lithium battery, sealed for water-resistance.

	HIGH	LOW
LUMENS:	350	135
CANDELA:	3,500	1,700
DISTANCE:	118m	80m
RUN TIME:	2.25h	5h

NFPA

Meets requirements of NFPA 1971-B.6 (2018); 500° heat resistance test

BATTERY: (1) CR123A lithium
SIZE WITH INDUSTRIAL MOUNT: 2.37" x 1.16" x 1.54" (6.02 x 2.95 x 3.91 cm)
INDUSTRIAL MOUNT WEIGHT: 2.97 oz. (84.2g)
SIZE WITH FIRE MOUNT: 2.37" x 1.16" x 2.18" (6.01 x 2.95 x 5.54 cm)
FIRE MOUNT WEIGHT: 3.65 oz. (103.5g)
COLOR: Black

ITEM #	DESCRIPTION
69331	Vantage II - [Fire] - Includes CR123A lithium battery
69333	Vantage II - [Industrial] - Includes CR123A lithium battery
69337	Vantage II - [for MSA Cairns® 1010/1044 Traditional Fire Helmets] with CR123A lithium battery
69334	Bracket Kit - Fire
69336	Bracket Kit - Industrial
69339	Bracket Kit - for MSA Cairns® 1010/1044 Traditional Fire Helmets

All rights reserved. Cairns® is a registered trademark of the Cairns Trademark Trust.



Fire model



Attaches securely to your helmet - above or below brim in seconds!



Large push-button switch features blue taillight LED that ensures you can be seen even from behind.



Industrial model



Industrial model features hard hat mount that slides into V-Guard slot.



DUALIE/PROPOLYMER SERIES //

SAFETY-RATED LIGHTING
BECAUSE YOU DON'T GET TO CHOOSE
WHERE IT'S GOING TO BE DARK

Streamlight builds more safety-rated lights to give you more options in hazardous locations. With our comprehensive product line of Dualies and ProPolymers, you have a full selection of hand-held safety-rated lights no matter your lighting need... spot, flood, laser or true color recognition with Streamlight's Color-Rite Technology.



DUALIE®
RECHARGEABLE



DUALIE® 2AA



4AA PROPOLYMER® LUX



DUALIE® 3AA COLOR-RITE®



STREAMLIGHT SAFETY-RATED LIGHTING TOOLS

// DIFFERENT LIGHTS FOR DIFFERENT HAZARDOUS LOCATIONS.

The National Electric Code (NEC) defines hazardous locations by “class” and “division.” There are three classes:



CLASS I locations are made hazardous by the presence of flammable gases, liquids or vapors.



CLASS II locations are hazardous because combustible dusts are present.



CLASS III locations contain easily ignitable fibers or flyings.

The “Division” designation refers to the likelihood that ignitable concentrations of flammable materials are present. There are two divisions:



DIVISION 1 designates an environment where ignitable concentrations of flammable gases, liquids, vapors or dusts can exist some of the time or all of the time under normal operating conditions, or where easily ignitable fibers and flyings are manufactured, handled or used.



DIVISION 2 locations are where ignitable concentrations are not likely to exist under normal operating conditions or where Class 3 materials are stored or handled.

Hazardous classes are further defined by “groups” based on the physical properties of their combustible materials. These groups include (but are not limited to):



GROUP A Acetylene

GROUP B Hydrogen

GROUP C Ethylene, Carbon Monoxide

GROUP D Propane, gasoline, naphtha, benzene, butane, ethyl alcohol, acetone, methane



GROUP E Metals including aluminum, magnesium (Div. 1 only)

GROUP F Carbonaceous dusts including coal, carbon black, coke

GROUP G Dusts not included in E and F including wood, plastics, flour, starch or grain dusts



STREAMLIGHT GIVES YOU MORE SAFETY-RATED LIGHTS FOR MORE OPTIONS IN HAZARDOUS LOCATIONS.

Streamlight flashlights are tested and certified by the world's leading independent laboratories — including Underwriters Laboratories, ATEX, Demko, and the Mine Safety and Health Administration (MSHA). This testing is your assurance that the Streamlight flashlight you choose will be safe in the environment(s) in which you'll be using it.



// STREAMLIGHT'S HAZ-LO SERIES OF LIGHTING TOOLS PROVIDE DIFFERENT PATHS TO THE SAME RESULT: A DIVISION 1 RATING!

When working in a Division 1 area, we expect explosive atmospheres to be present. Streamlight's HAZ-LO product line is suitable for use in Division 1 areas. Streamlight uses different protection standards and testing at Nationally Recognized Test Labs (NRTL) to achieve the Division 1 rating that is common to all Streamlight HAZ-LO Lighting. This is the best possible performance while ensuring that your flashlight will not become an ignition source. ANSI/UL 783 is the specific standard for flashlights used in hazardous locations. ANSI/UL 913 is the intrinsically safe standard for general electronic equipment. While either standard can direct certification to Division 1 level, it is important to note Class, Group and Temperature code requirements to select the correct flashlight for specific applications.



Scan or click to watch our video:
"You Bet Your Light On It:
Safety Ratings Explained"

// WHY ARE SAFETY RATINGS IMPORTANT?

There are several types of locations in which it can be extremely dangerous to use any light that has not been specifically designed — and approved — for that kind of location. These are areas where fire or explosion hazards may exist due to the presence of flammable gases, liquids, vapors, dusts, or ignitable fibers or flyings. If you will be using a flashlight in any potentially hazardous location, it is critical that your light be safety-rated for that specific kind of environment.

// ATEX RATINGS

Streamlight also offers safety-rated lights that comply with the European Union (EU) Directive 2014/34/EU (ATEX) for products intended for use in potentially explosive atmospheres within the EU member countries. Please visit our website, streamlight.com for more information on ATEX-rated products. We also have a catalog of ATEX-rated products available upon request.



THE DUALIE FAMILY OF LIGHTS
HANDS-FREE & INCREDIBLY VERSATILE



The Dualie design allows you to see what's ahead of you and right in front of your feet. Its bright light helps you avoid slips, trips and falls.

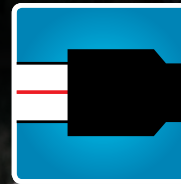

The Dualie Laser features a simultaneous spot beam and laser pointer allowing you to illuminate the work area and pinpoint out-of-reach objects.

DUALIE® RECHARGEABLE

The Dualie Rechargeable features a lithium-ion battery and dual beams — forward facing LED spot beam and a side facing LED flood light that can be used individually or at the same time for enhanced safety. Integrated, non-protruding spring loaded belt clip contained within body outline. Optional magnetic clip for hands-free use. IP67-rated; dust-tight and waterproof to 1m for 30 minutes; 2m impact resistance tested.



Integrated magnet for hands-free use

	SPOT	FLOOD	COMBO
LUMENS:	180	105	275
CANDELA:	11,500	60	-
DISTANCE:	171m	18m	-
RUN TIME:	7h 15m	13h 30m	5h 30m



Class I, II; Div. I
Grps. A, B, C, D, E, F, G
Class III, T-Code: T4

BATTERY: Lithium-ion
SIZE: 7" x 1.86" x 1.06" (17.78 x 4.72 x 2.69 cm)
WEIGHT: 6.8 oz. (193g) // 7.09 oz. (201g) w/Magnetic clip
COLOR: Yellow or Black

WITHOUT MAGNETIC CLIP	WITH MAGNETIC CLIP	DESCRIPTION
68732	68793	120V/100V AC - Yellow
68733	68794	120V/100V AC - Black
68734	68795	12V DC - Yellow
68735	68796	12V DC - Black
68730	68785	Light only - Yellow
68731	68786	Light only - Black



DUALIE® 3AA

One light, two beams: choose one spot beam or one flood light or both. The 3AA Dualie provides two types of illumination for multi-directional lighting and special uses. Intuitive activation allows you to use either beam or both at the same time. This intrinsically safe flashlight allows you to see your entire work area and helps you avoid slips, trips, and falls. Optional magnetic clip for hands-free use. IP67-rated; waterproof to 1 meter for 30 minutes; 2m impact resistance tested.

	SPOT	FLOOD	COMBO
LUMENS:	140	140	245
CANDELA:	7,300	80	-
DISTANCE:	171m	8m	-
RUN TIME:	18h	18h	9h



Integrated magnet for hands-free use



BATTERY: (3) "AA" alkaline
SIZE: 7" x 1.86" x 1.06" (17.78 x 3.86 x 2.69 cm)
WEIGHT: 6.8 oz. (193g); 7.1 oz. (201g) with magnetic clip
COLOR: Yellow or Black

ITEM #	DESCRIPTION
68750	Dualie 3AA - With batteries - Clam - Yellow
68752	Dualie 3AA - With batteries - Clam - Black
68751	Dualie 3AA - Without batteries - Mailer - Yellow
68753	Dualie 3AA - Without batteries - Mailer - Black
68782	Dualie 3AA Magnet - Includes alkaline batteries & lanyard - Box - Yellow
68783	Dualie 3AA Magnet - Includes alkaline batteries & lanyard - Box - Black
68780	Dualie 3AA Magnet - without batteries - Box - Yellow
68781	Dualie 3AA Magnet - without batteries - Box - Black



Class I, II, Div. 1,
Grps. A, B, C, D, E, F, G;
Class III, T-Code: T4



Permissible Flashlight
App. No. 20-A160001-0
Tested for use in methane-air
mixtures only

DUALIE® 3AA LASER

The Dualie 3AA Laser is an intrinsically safe, high performance, battery powered multi-function LED flashlight. The Dualie Laser model features forward facing LED spot beam and laser pointer that can be used individually or at the same time for location identification. Opposing switches for easy user activation of desired functions. IP67-rated; dust-tight and waterproof to 1 meter for 30 minutes; 2m impact resistance tested.

BATTERY: (3) "AA" alkaline
SIZE: 7" x 1.86" x 1.06" (17.78 x 3.86 x 2.69 cm)
WEIGHT: 6.8 oz. (193g)
COLOR: Yellow or Black

	LED	LASER
LUMENS:	150	<5mW output
CANDELA:	7,700	--
DISTANCE:	175m	--
RUN TIME:	17h	70h



Class I, II, Div. 1,
Grps. A, B, C, D, E, F, G;
Class III, T-Code: T4



Permissible Flashlight
App. No. 20-A160001-0
Tested for use in methane-air
mixtures only

ITEM #	DESCRIPTION
68760	Dualie 3AA Laser - Includes "AA" alkaline batteries - Yellow
68762	Dualie 3AA Laser - Includes "AA" alkaline batteries - Black

DUALIE® 3AA COLOR-RITE®

The Dualie® 3AA Color-Rite® is an intrinsically safe, high performance, 3 “AA” battery powered flashlight that produces a bright, white light to see ahead of you. The flood beam uses a high output CRI LED for true color recognition. It has opposing switches for easy user activation of desired function.

Body features a superior grip texture to provide a comfortable but slip resistant feel and is constructed of an engineered polymer resin that is virtually indestructible, shock resistant, non-conductive and light weight. The integrated, non-protruding spring loaded belt clip is contained within the body outline. So much power and technology in one place!

IP67-rated; dust-tight and waterproof to 1 meter for 30 minutes; 2m impact resistance tested.

BATTERY: (3) “AA” alkaline or lithium
SIZE: 7" x 1.52" x 1.06" (17.78 x 3.86 x 2.69 cm)
WEIGHT: 6.6 oz. (187g)
COLOR: Yellow



Class I, II; Div. I
 Grps. A, B, C, D, E, F, G
 Class III, T-Code: T4

	SPOT (COOL WHITE)	FLOOD (WARM WHITE)	COMBO
LUMENS:	225	175	320
CANDELA:	8,000	380	7,000
DISTANCE:	179m	39m	167m
RUN TIME:	8h	8.5h	5h

FLOOD/WARM WHITE COLOR TEMPERATURE: 4,000K



**Color-
Rite®**



DUAL BEAM DESIGN:

The Dualie design produces either a spot beam with a cool white LED or a flood beam that uses a CRI LED for true color recognition.

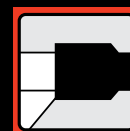

ITEM #	DESCRIPTION
68910	Dualie 3AA Color-Rite - Includes (3) "AA" alkaline batteries

DUALIE® 2AA

The Dualie 2AA is an intrinsically safe, high performance, battery powered multi-function LED flashlight. The flashlight features a forward facing LED spot beam and a side facing LED flood light that can be used individually or at the same time for enhanced safety. The flashlight has opposing switches for easy user activation of desired function(s). Includes removable, reversible clip and integrated magnet. IPX4-rated; water-resistant.



Integrated magnet for hands-free use

	SPOT	FLOOD	COMBO
LUMENS:	115	115	175
CANDELA:	3,100	75	-
DISTANCE:	111m	17m	-
RUN TIME:	24h	24h	15h

BATTERY: (2) “AA” alkaline
SIZE: 6.10" x 1.34" x 0.87" (15.5 x 3.4 x 2.2 cm)
WEIGHT: 3.9 oz. (111g)
COLOR: Yellow or Black

ITEM #	DESCRIPTION
67751	Dualie 2AA - Includes Alkaline batteries - Box - Yellow
67752	Dualie 2AA - Includes Alkaline batteries - Clam - Black



Class I, II, Div. 1,
 Grps. A, B, C, D, E, F, G;
 Class III, T-Code: T4

2AAA PROPOLYMER® HAZ-LO®

LUMENS:	60
CANDELA:	800
DISTANCE:	57m
RUN TIME:	16h



Class I, II, Div. 1,
Grps. A, B, C, D, E, F, G;
Class III; CL I, ZN O, IIC;
T-Class: T4A



The 2AAA ProPolymer HAZ-LO is an extremely durable, alkaline battery-powered, intrinsically safe flashlight. This light features a push-button tailswitch for momentary on or on-off operation and integrated pocket clip. IPX4-rated; water-resistant; 1m impact resistance tested.

BATTERY: (2) "AAA" alkaline
SIZE: 5.40" x 1" x 0.66" (13.7 x 2.5 x 1.7 cm)
WEIGHT: 1.9 oz. (54g)
COLOR: Yellow

ITEM #	DESCRIPTION
66500	2AAA ProPolymer HAZ-LO - Includes alkaline batteries - Clam
66505	2AAA ProPolymer HAZ-LO - Includes alkaline batteries - Box

2AA PROPOLYMER® HAZ-LO®

LUMENS:	65
CANDELA:	2,300
DISTANCE:	96m
RUN TIME:	24h



Permissible Flashlight.
Approval No. 20-A140002-D.
Tested for Intrinsic Safety in
Methane-Air mixtures only.



Class I, II, Div. 1,
Grps. A, B, C, D, E, F, G;
Class III; T-Class: T4



This virtually indestructible safety-rated flashlight is long on run time and small enough to fit in a pocket or strap onto a helmet. Provides a focused beam with optimum peripheral illumination. O-ring sealed construction. IPX7-rated; waterproof to 1m for 30 minutes.

BATTERY: (2) "AA" alkaline
SIZE: 6.4" x 1.32" x 0.89" (16.26 x 3.35 x 2.26 cm)
WEIGHT: 3.6 oz. (100g)
COLOR: Yellow or Black

ITEM #	DESCRIPTION
67100	2AA ProPolymer HAZ-LO - Includes alkaline batteries - Clam - Black
67101	2AA ProPolymer HAZ-LO - Includes alkaline batteries - Clam - Yellow

STYLUS PRO® HAZ-LO® **NEW**

The Stylus Pro HAZ-LO is an intrinsically safe and extremely durable alkaline battery-powered penlight. It features a tail cap switch with momentary and "constant on" operation, a replaceable metal pocket clip, and amazing brightness for a light of its size. Impact and chemical-resistant engineered polymer resin construction; non-conductive. Unbreakable polycarbonate lens. IPX7-rated; waterproof to 1m for 30 minutes, 2 meter impact resistance tested.

LUMENS:	105
CANDELA:	380
DISTANCE:	39m
RUN TIME:	2.25h



Class I, II, Div. 1,
Grps. A, B, C, D, E, F, G;
Class III; T-Class: T3/T4

BATTERY: (2) "AAA" alkaline
SIZE: 5.92" x 0.78" x 0.63" (15 x 2 x 1.6 cm)
WEIGHT: 1.9 oz. (54g)
COLOR: Yellow

ITEM #	DESCRIPTION
66300	Stylus Pro HAZ-LO - Includes alkaline batteries



STREAMLIGHT PROPOLYMER SERIES



4AA PROPOLYMER® LED

Its soft, diffused light is perfect for up close work, and with 155 hrs. of run time, this safety-rated light is always ready. Contains seven ultra-bright LEDs. IP65-rated; waterproof, dust-resistant. Unbreakable, scratch-resistant lens.

BATTERY: (4) "AA" alkaline
SIZE: 6.5" x 1.63" x 1.34" (16.51 x 4.14 x 3.4 cm)
WEIGHT: 6.3 oz. (178.6g)
COLOR: Yellow or Black

LUMENS:	67
RUN TIME:	155h



YELLOW	BLACK	DESCRIPTION
68200	68300	4AA ProPolymer LED - without alkaline batteries - Box
68201	68301	4AA ProPolymer LED - Includes alkaline batteries - Box
68202	68302	4AA ProPolymer LED - Includes alkaline batteries - Clam



Class I, Div. 1, Grps. C, D;
 Class I, Div. 2, Grps. A, B, C, D;
 Class II, Div. 2, Grps. F, G;
 Class III, T-Code: T3C



Class I, Div. 2, Grps. A, B, C, D;
 Class II, Div. 2, Grps. F, G;
 Class III, T-Code: T3C



Permissible Flashlight
 App. No. 10C-658-0
 Tested for use in
 methane-air mixtures only

4AA PROPOLYMER® LUX

This safety-rated light has a long-reaching, bright beam and an ergonomic design for comfortable handling. Unbreakable, scratch-resistant lens. IP67-rated; waterproof to 1 meter for 30 minutes. 1 meter impact-resistance tested. Corrosion-proof.

BATTERY: (4) "AA" alkaline
SIZE: 7" x 1.48" x 1.69" (17.8 x 3.76 x 4.29 cm)
WEIGHT: 7.6 oz. (216g)
COLOR: Yellow or Black

LUMENS:	200
CANDELA:	12,000
DISTANCE:	219m
RUN TIME:	6h



4AA Lux Div. 1

Class I, II, Div. 1, Grps. C, D, F, G;
 Class I, Div. 2, Grps. A, B, C, D;
 Class III, T-Code: T4



Class I, II, Div. 1, Grps. C, D, F, G;
 Class I, Div. 2, Grps. A, B, C, D
 Class III, T-Code: T4



4AA Lux Div. 2

Class I, Div. 2, Grps. A, B, C, D;
 Class II, Div. 2, Grps. F, G;
 Class III, T-Code: T3C



Class I, Div. 2, Grps. A, B, C, D;
 Class II, Div. 2, Grps. F, G;
 Class III, T-Code: T3C

YELLOW	BLACK	DESCRIPTION
68244	68344	4AA Propolymer Lux Div. 2 - Includes alkaline batteries
68602	68702	4AA Propolymer Lux Div. 1 - Includes alkaline batteries

WEAPON-MOUNTED SERIES //

WEAPON-MOUNTED LIGHTING SPECIALISTS

**WE BUILD A RANGE OF LIGHTS FOR LONG GUN,
FULL-FRAME, COMPACT & SUBCOMPACT PISTOLS**

Streamlight proudly builds our full line of weapon-mounted lights with features and performance levels to fill the needs of military, law enforcement, concealed carry and sportsmen. From IR to high-lumen to laser, Streamlight TLRs lead the industry.

PROTAC® RAIL MOUNT 2



TL-RACKER®



TLR-7® HL-X



TLR-1 HL®



TLR-1 HL®-X



LIGHT ONLY

COMPACT & FULL FRAME PISTOLS UNIVERSAL RAIL MOUNT MODELS



TLR-1 HL[®]-X



TLR-1 HL[®]



TLR-1[®] //
TLR-1[®]s



TLR-3[®]



TLR-7[®] X



TLR-7[®] X
CONTOUR REMOTE



TLR-7[®] HL-X USB



TLR-9[®]

SUBCOMPACT & COMPACT PISTOLS TRIGGER GUARD & RAIL MOUNT MODELS



TLR-6[®]
NON-LASER



TLR-7[®] X



TLR-7[®] HL-X USB



TLR-7[®] X sub



TLR-7[®] HL-X sub

LONG GUN/AR SHOTGUN FOREND & RAIL MOUNT MODELS



TL-RACKER[®]



TLR[®] RM1



TLR[®] RM2



PROTAC[®]
RAIL MOUNT 1



PROTAC[®]
RAIL MOUNT 2



PROTAC[®] RAIL
MOUNT HL-X



PROTAC[®] RAIL
MOUNT HL-X PRO



PROTAC[®] 2.0
RAIL MOUNT



TLR-1 HL[®]
[Long Gun Kit]



TLR-1 HPL[®]
[Long Gun Kit]

LIGHT/LASER COMBO

COMPACT & FULL FRAME PISTOLS UNIVERSAL RAIL MOUNT MODELS



TLR-2® // TLR-2^s



TLR-2 HL®



TLR-2^G // TLR-2 HL^G



TLR-8^A



TLR-8^{A G}



TLR-10® // TLR-10^G

SUBCOMPACT & COMPACT PISTOLS TRIGGER GUARD & RAIL MOUNT MODELS



TLR-4® // TLR-4^G



TLR-6®



TLR-6 HL® // TLR-6 HL^G



TLR-8^A



TLR-8^{A G}



TLR-8^{sub} // TLR-8^{G sub}

LONG GUN/AR RAIL MOUNT MODELS



TLR-2® // TLR-2^s



TLR-2 HL®



TLR-2 HL^G



TLR[®] RM 1 LASER
RED // GREEN



TLR[®] RM 2 LASER
RED // GREEN



PROTAC[®] RAIL MOUNT
HL-XLASER

SPECIALTY/IR LONG GUN/AR & FULL FRAME PISTOLS



TLR-VIR[®] II



It can be difficult to choose the right weapon-mounted light for your specific gun and application. We want to make the process easier. That's why we designed the TLR Fit Guide to make it easy for you to select the right light for your weapon.

SCAN OR CLICK THE QR CODE TO VIEW OUR TLR FIT GUIDE

Understanding Streamlight Gun Light Beam Patterns

Having the right flashlight that meets your lighting needs is important. That's one of the reasons Streamlight developed three series of lights: Tradition, High Lumen (HL) and High Performance High Lumen (HPL). Each series offers a different balance of features and can be used for a variety of applications.

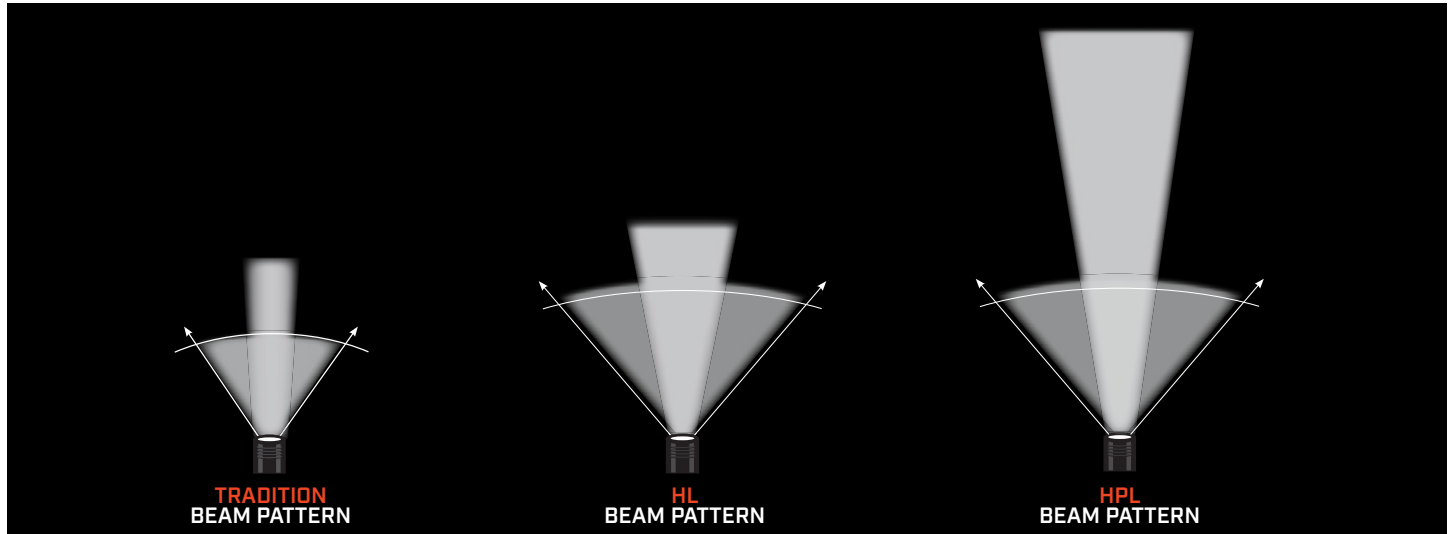

We understand it can sometimes be difficult to determine which lights work best for a variety of applications. When choosing a flashlight, keep the following in mind:

Tradition Series: Meant for general, multi-purpose use, these lights are designed for the broadest range of lighting applications at the best value.

Performance Characteristics	Examples of Available Products
<ul style="list-style-type: none"> • Optimal balance of candela and lumens - the beam pattern most people expect out of a quality flashlight • Very good all-around use, broadest range of lighting applications • Good focus and arc/periphery light • Longest regulated run times • The best value 	<ul style="list-style-type: none"> • TLR-1®/TLR-1®s • TLR-2®/TLR-2®s • TLR-3® • TLR-4® • TLR-6® • TLR-7® X • TLR-7® sub • TLR-7® HL-X sub • TLR-7® X Contour Remote • TLR-8® A/TLR-8® A G • TLR-8® sub/TLR-8® G sub • TLR-9® • TLR-10®/TLR-10® G • ProTac® Rail Mount 1 • ProTac® Rail Mount 2

High Lumen (HL): Gives you maximum illumination, providing full situational awareness by delivering extraordinary brightness in a wide beam pattern. These lights are ideal for smaller areas where you need a lot of light, but not an exceptionally long reach.

Performance Characteristics	Examples of Available Products
<ul style="list-style-type: none"> • High lumen beam • Delivers maximum illumination - a broader beam pattern with a wider center spot • Provides a good level of candela • Ideal for room search, illuminating an entire vehicle 	<ul style="list-style-type: none"> • TLR-1 HL® • TLR-1 HL®-X • TLR-2 HL®/TLR-2 HL® G • TLR-6 HL®/TLR-6 HL® G • ProTac® Rail Mount HL-X • ProTac® Rail Mount HL-X Pro • ProTac® Rail Mount HL-X Laser • ProTac® 2.0 Rail Mount

High Performance High Lumen (HPL): A good choice for down-range applications requiring optimal beam distance, as these flashlights throw light a long distance and feature a higher lumen output.

Performance Characteristics	Examples of Available Products
<ul style="list-style-type: none"> • High-candela beam • Tight focused center spot for greater down-range light • Sheds a bright peripheral beam • More light on your target at a distance 	<ul style="list-style-type: none"> • TLR-1 HPL® • TLR® RM 1/TLR® RM 1 Laser • TLR® RM 2/TLR® RM 2 Laser • TLR-7® HL-X USB



TLR-1 HL[®]
WHITE LIGHT ILLUMINATOR



This versatile tactical light fits handguns and long-guns, and you can switch from one to the other in seconds. Its wide peripheral beam lets you see what's all around you, including what's lurking in corners. Includes a strobe for signaling/disorienting. Unbreakable, scratch-resistant, gasket-sealed lens. Impact resistant. Easy, fast battery installation/replacement. IPX7-rated; waterproof to 1m for 30 minutes.

BATTERY: (2) CR123A lithium
SIZE: 3.39" x 1.47" x 1.44" (8.61 x 3.73 x 3.65 cm)
WEIGHT: 4.32 oz. (122.5g)
COLORS: Black, Flat Dark Earth or Brown

LUMENS:	1,000
CANDELA:	20,000
DISTANCE:	283m
RUN TIME:	1.5h

[(STROBE)]
Double tap
switch to activate



Available in Black,
Flat Dark Earth and
Flat Dark Earth Brown

ITEM #	DESCRIPTION
69260	TLR-1 HL - Includes rail locating keys for use with GLOCK [®] style, 1913 Picatinny, Smith & Wesson [®] 99/TSW, SIG SAUER P320 [®] and Beretta [®] 90-TWO and lithium batteries - Black
69266	TLR-1 HL - Includes rail locating keys for use with GLOCK [®] style, 1913 Picatinny, Smith & Wesson [®] 99/TSW, SIG SAUER P320 [®] and Beretta [®] 90-TWO and lithium batteries - Flat Dark Earth
69267	TLR-1 HL - Includes rail locating keys for use with GLOCK [®] style, 1913 Picatinny, Smith & Wesson [®] 99/TSW, SIG SAUER P320 [®] and Beretta [®] 90-TWO and lithium batteries - Flat Dark Earth Brown
69262	TLR-1 HL - Long Gun Kit Includes Safe off remote door switch, remote pressure switch, mounting clips, standard door switch and lithium batteries - Black
69888	TLR-1 HL - Long Gun Kit Includes safe off remote door switch, remote pressure switch, mounting clips, standard door switch and lithium batteries - Flat Dark Earth
69889	TLR-1 HL - Dual Remote Kit Includes dual remote pressure switch, "safe off" door switch, mounting clips and lithium batteries - Black



TLR-1 HL Long Gun Kit



TLR-1 HL Dual Remote Kit

TLR-1 HL[®]-X

THE TLR-1 HL SERIES GOES RECHARGEABLE!

TLR-1 HL[®]-X
WHITE LIGHT ILLUMINATOR



The multi-fuel TLR-1 HL-X produces a powerful 1,500 lumen beam. It uses two SL-B9 USB rechargeable protected lithium-ion battery backs; also accepts CR123A batteries. Front loading batteries for easy, fast battery replacement without removing the light from the firearm. User interchangeable switches. IPX7-rated; waterproof to 1m for 30 minutes.

BATTERY: (2) SL-B9 battery packs or CR123A lithium
SIZE: 3.45" x 1.44" x 1.44" (8.76 x 3.66 x 3.66 cm)
WEIGHT: 5.19 oz. (147g) SL-B9 // 4.94 oz. (140g) CR123A
COLOR: Black

ITEM #	DESCRIPTION
69500	TLR-1 HL-X - Includes rail locating keys and (2) CR123A lithium batteries
69501	TLR-1 HL-X USB - Includes rail locating keys, (2) SL-B9 battery packs and USB-C cord

SL-B9	LUMENS: 1,500
	CANDELA: 20,000
	DISTANCE: 283m
	RUN TIME: 1h
CR123A	LUMENS: 1,000
	CANDELA: 15,000
	DISTANCE: 245m
	RUN TIME: 1.5h

MULTI-FUEL DESIGN:

Runs on (2) SL-B9 battery packs or CR123A batteries



Front-loading batteries; rapid battery replacement without removing the light from the firearm



TLR-1® // TLR-1s®
WHITE LIGHT ILLUMINATOR

Intensely bright, durable, tactical light available in standard or strobe. Securely fits a broad range of weapons. Produces a concentrated beam with optimum peripheral illumination. Mounts directly to handguns with GLOCK® style rails and to all MIL-STD-1913 (Picatinny) rails. IPX7-rated; waterproof to 1 meter for 30 minutes. Impact resistant. Strobe mode (TLR-1s only) can be disabled.

BATTERY: (2) CR123A lithium
SIZE: 3.39" x 1.47" x 1.44" (8.61 x 3.73 x 3.65 cm)
WEIGHT: 4.18 oz. (118.6g)
COLOR: Black

LUMENS:	300
CANDELA:	12,000
RUN TIME:	2.5h



[(STROBE)]
Double tap
switch to activate

ITEM #	DESCRIPTION
69110	TLR-1 – Includes rail locating keys for use with GLOCK® style, 1913 Picatinny, Smith & Wesson® 99/TSW, SIG SAUER P320® and Beretta® 90-TWO and lithium batteries
69210	TLR-1s – Includes rail locating keys for use with GLOCK® style, 1913 Picatinny, Smith & Wesson® 99/TSW, SIG SAUER P320® and Beretta® 90-TWO and lithium batteries

TLR-2 HL®

WHITE LIGHT ILLUMINATOR / RED LASER



This versatile tactical light fits handguns and long-guns, and you can switch from one to the other in seconds. Its wide peripheral beam lets you see what's all around you, including what's lurking in corners. Includes a strobe for signaling/disorienting. Unbreakable, scratch-resistant, gasket-sealed lens. Impact resistant. Easy, fast battery installation/replacement. IPX4-rated; water-resistant and features a 640-660nm red laser.

BATTERY: (2) CR123A lithium
SIZE: 3.39" x 1.47" x 1.83" (8.61 x 3.73 x 4.64 cm)
WEIGHT: 4.88 oz. (138.4g)
COLOR: Black

LUMENS:	1,000
CANDELA:	20,000
DISTANCE:	283m
RUN TIME:	1.5h
LASER MODE: RUNS 45 HOURS	



[(STROBE)]
 Double tap
 switch to activate

ITEM #	DESCRIPTION
69261	TLR-2 HL - Includes Rail locating keys for use with GLOCK® style, 1913 Picatinny, Smith & Wesson® 99/TSW, SIG SAUER P320® and Beretta® 90-TWO and lithium batteries

TLR-2 HL® G

WHITE LIGHT ILLUMINATOR / GREEN LASER



Features a highly visible (even in daylight) green laser that assists in target acquisition. Its wide peripheral beam lets you see what's all around you, including what's lurking in corners. Includes a strobe for signaling/disorienting. Unbreakable, scratch-resistant, gasket-sealed lens. Impact resistant. Easy, fast battery installation/replacement. IPX4-rated; water-resistant and features a 510-530nm green laser.

BATTERY: (2) CR123A lithium
SIZE: 3.39" x 1.47" x 1.83" (8.61 x 3.73 x 4.64 cm)
WEIGHT: 4.88 oz. (138.4g)
COLOR: Black

LUMENS:	1,000
CANDELA:	20,000
DISTANCE:	283m
RUN TIME:	1.5h
LASER MODE: RUNS 17 HOURS	



[(STROBE)]
 Double tap
 switch to activate

ITEM #	DESCRIPTION
69265	TLR-2 HL G - Includes rail locating keys for use with GLOCK® style, 1913 Picatinny, Smith & Wesson® 99/TSW, SIG SAUER P320® and Beretta® 90-TWO and lithium batteries





TLR-2® // TLR-2s®

WHITE LIGHT ILLUMINATOR / RED LASER

Intensely bright, durable, tactical light securely fits a broad range of weapons. Produces a concentrated beam with optimum peripheral illumination. Features an integrated 650-660nm red laser. Mounts directly to handguns with GLOCK® style rails and to all MIL-STD-1913 (Picatinny) rails. IPX4-rated; water-resistant. Impact resistant. Strobe mode (TLR-2s only) can be disabled.

BATTERY: (2) CR123A lithium
SIZE: 3.39" x 1.47" x 1.83" (8.61 x 3.73 x 4.64 cm)
WEIGHT: 4.72 oz. (133.8g)
COLOR: Black

LUMENS: 300
CANDELA: 12,000
RUN TIME: 2.5h
 LASER MODE: RUNS 48 HOURS



[(STROBE)]

Double tap switch to activate

ITEM #	DESCRIPTION
69120	TLR-2 – Includes rail locating keys for use with GLOCK® style, 1913 Picatinny, Smith & Wesson® 99/TSW, SIG SAUER P320® and Beretta® 90-TWO and lithium batteries
69230	TLR-2s – Includes rail locating keys for use with GLOCK® style, 1913 Picatinny, Smith & Wesson® 99/TSW, SIG SAUER P320® and Beretta® 90-TWO and lithium batteries

TLR-2® G

WHITE LIGHT ILLUMINATOR / GREEN LASER

Features a highly visible (even in daylight) 510-530nm green laser that assists in target acquisition. Mounts directly to handguns with GLOCK® style rails and to all MIL-STD-1913 (Picatinny) rails. IPX4-rated; water-resistant. Strobe can be disabled.

BATTERY: (2) CR123A lithium
SIZE: 3.39" x 1.47" x 1.83" (8.61 x 3.73 x 4.64 cm)
WEIGHT: 4.72 oz. (133.8g)
COLOR: Black

LUMENS: 300
CANDELA: 12,000
RUN TIME: 2.5h
 LASER MODE: RUNS 17 HOURS



[(STROBE)]

Double tap switch to activate

ITEM #	DESCRIPTION
69250	TLR-2 G – Includes rail locating keys for use with GLOCK® style, 1913 Picatinny, Smith & Wesson® 99/TSW, SIG SAUER P320® and Beretta® 90-TWO and lithium batteries

TLR-3[®]

WHITE LIGHT ILLUMINATOR

Lightweight and powerful, this light is designed for sub-compact and compact weapons, yet it fits the broadest array of handguns – up to full size. Operates in extreme temperatures. Impact-resistant polymer construction with durable anodized aluminum facecap. IPX7-rated; waterproof to 1m for 30 minutes.

BATTERY: (2) CR2 lithium
SIZE: 2.71" x 1.18" x 1.51" (6.88 x 3.00 x 3.84 cm)
WEIGHT: 2.32 oz. (65.8g)
COLOR: Black

LUMENS:	170
CANDELA:	3,300
DISTANCE:	115m
RUN TIME:	1.5h



ITEM #	DESCRIPTION
69220	TLR-3 - Includes rail locating keys and CR2 lithium battery
69221	TLR-3 H&K USP Compact - Includes CR2 lithium battery
69222	TLR-3 H&K USP Full-Size - Includes CR2 lithium battery

TLR-4[®]

WHITE LIGHT ILLUMINATOR / RED LASER

Designed for sub-compact and compact weapons, this white light illuminator features an integrated 640-660nm red aiming laser. Operates in extreme temperatures. Impact-resistant polymer body; anodized aluminum facecap. IPX4-rated; water-resistant.

BATTERY: (1) CR2 lithium
SIZE: 2.73" x 1.20" x 1.99" (6.93 x 3.05 x 5.05 cm)
WEIGHT: 2.81 oz. (79.7g)
COLOR: Black

LUMENS:	170
CANDELA:	3,300
DISTANCE:	115m
RUN TIME:	1.5h
LASER MODE: RUNS 15 HOURS	



ITEM #	DESCRIPTION
69240	TLR-4 - Includes rail locating keys for use with Picatinny or Glock [®] style rails and CR2 lithium battery
69241	TLR-4 H&K USP Compact - Includes CR2 lithium battery
69242	TLR-4 H&K USP Full-Size - Includes CR2 lithium battery

TLR-4[®] G

WHITE LIGHT ILLUMINATOR / GREEN LASER

Designed for sub-compact and compact weapons, this white light illuminator features an integrated 510-530nm green laser that can be seen even in daylight. Impact-resistant polymer body; anodized aluminum face cap. IPX4-rated; water-resistant.

BATTERY: (1) CR2 lithium
SIZE: 2.73" x 1.20" x 1.99" (6.93 x 3.05 x 5.05 cm)
WEIGHT: 2.81 oz. (79.7g)
COLOR: Black

LUMENS:	160
CANDELA:	3,200
DISTANCE:	113m
RUN TIME:	1.75h LED ONLY
RUN TIME:	1.25h LED + LASER
LASER MODE: RUNS 4 HOURS	



ITEM #	DESCRIPTION
69245	TLR-4 G - Includes rail locating keys for use with Picatinny or Glock [®] style rails and CR2 lithium battery
69246	TLR-4 G H&K USP Compact - Includes CR2 lithium battery
69247	TLR-4 G H&K USP Full-Size - Includes CR2 lithium battery



TLR-VIR® II

WHITE LIGHT ILLUMINATOR / IR ILLUMINATOR & IR LASER COMBO

LUMENS:	300
CANDELA:	5,000
IR OUTPUT:	600mW/sr
VISIBLE RUN TIME:	1.5h
IR RUN TIME:	12h

Designed to be used with a pistol or long gun. Features a White LED Illuminator and Combo IR Illuminator/IR Laser. Has a seamless design so you can easily switch from white light to IR all while keeping your eyes on the target or the threat. Class 1 eye safe IR Laser, 850nm, output power less than 0.8mW, with 3 mrad adjustment increment markings and tactile indicator on housing identifying IR Illumination position. IPX7-rated; waterproof to 1 meter for 30 minutes.



[(STROBE)]

Double tap
switch to activate



BATTERY: (1) CR123A lithium
SIZE: 3.3" x 1.45" x 1.4" (8.39 x 3.69 x 3.56cm)
WEIGHT: 3.82 oz. (108g) with batteries
COLORS: Coyote or Black



ITEM #	DESCRIPTION
69191	TLR-VIR II - visible LED/IR illuminator/IR laser – Includes rail locating keys and CR123A lithium battery – Coyote
69192	TLR-VIR II - visible LED/IR illuminator/IR laser – Includes rail locating keys and CR123A lithium battery – Black



TLR-6[®]

ULTRA-COMPACT LIGHTS FOR COMPACT, SUB-COMPACT & CONCEALED CARRY WEAPONS

TLR-6[®] RAIL MOUNT

Designed to securely attach to the rail and the trigger guard of GLOCK[®] compact railed handguns, SIG SAUER[®], Smith and Wesson[®] M&P[®] standard and compact railed handguns. The compact TLR-6 rail mount weapon light with LED and integrated red aiming laser features tool-less battery replacement without removal of the weapon or the need to re-sight the laser. The light provides one hour of regulated runtime when in dual light/laser mode. Durable, Impact-resistant polymer construction.

BATTERY: (2) CR-1/3 N lithium
SIZE: 2.20" x 1.20" x 1.47" (5.58 x 3.04 x 3.73 cm)
Size & Weight vary by model
WEIGHT: 1.16 oz. (33g)
COLOR: Black

LUMENS:	100
CANDELA:	2,000
DISTANCE:	89m
RUN TIME:	1h
LASER MODE: RUNS 11 HOURS	



Red Laser #69290
GLOCK[®] 17/19/21



Red Laser #69291
SA XD



Red Laser #69293
M&P[®] Shield[™] 40/9

ITEM #	DESCRIPTION
69290	TLR-6 (GLOCK [®] 17/19/21) White LED/red laser – Includes (2) CR 1/3N lithium batteries
69291	TLR-6 (SA XD [®]) White LED/red laser – Includes (2) CR 1/3N lithium batteries
69293	TLR-6 (S&W M&P [®]) White LED/red laser – Includes (2) CR 1/3N lithium batteries

TLR-6® FOR SUBCOMPACT HANDGUNS

An industry first, the ultra-compact TLR-6 weapon light with white LED and integrated 640/660nm red aiming laser features tool-less battery replacement without removal from the weapon or the need to re-sight the laser. The light provides 1 hour of regulated runtime when in dual light/laser mode. Three operating modes - Light only / Light & laser / Laser only. Designed to securely attach to the trigger guard on hand guns. Durable, impact-resistant polymer construction.

BATTERY: (2) 3V CR-1/3 N lithium

SIZE: 2.30" x 0.85" x 1.42" (5.84 x 2.16 x 3.61 cm)

Size & Weight vary by model

WEIGHT: 1.27 oz. (36g)

COLORS: Black or Flat Dark Earth

LUMENS: 100
CANDELA: 2,000
DISTANCE: 89m
RUN TIME: 1h
 LASER MODE: RUNS 11 HOURS

Universal Kit #69277



Universal Kit includes one LED/laser Aiming module and the following shells: GLOCK 42, GLOCK 26, M&P Shield, KAHR ARMS, SIG SAUER, KIMBER Micro. (Flat Dark Earth, Rail Mount, 1911 & Non Laser models not included.)

ITEM #	DESCRIPTION
69270	TLR-6 (GLOCK® 42/43) White LED/red laser – Includes (2) CR 1/3N lithium batteries – Black
69272	TLR-6 (GLOCK® 26/27/33) White LED/red laser – Includes (2) CR 1/3N lithium batteries – Black
69277	TLR-6 Universal Kit – Includes LED/laser module and select TLR-6 body housings – Black
69273	TLR-6 (M&P® Shield™ 40/9) White LED/red laser – Includes (2) CR 1/3N lithium batteries – Black
69278	TLR-6 (GLOCK® 42/43) White LED/red laser – Includes (2) CR 1/3N lithium batteries – Flat Dark Earth
69284	TLR-6 (SIG SAUER® P365®/XL) White LED/red laser – Includes (2) CR 1/3N lithium batteries – Black
69286	TLR-6 (GLOCK® 43X/48 MOS and GLOCK® 43X/48 RAIL) White LED/red laser – Includes (2) CR 1/3N lithium batteries – Black
69287	TLR-6 (SA Hellcat®) White LED/red laser – Includes (2) CR 1/3N lithium batteries – Black
69288	TLR-6 (Taurus GX4™) White LED/red laser - Includes (2) CR 1/3N lithium batteries - Black
NON-LASER MODELS	
69280	TLR-6 (GLOCK® 42/43) without laser – White LED – Includes (2) CR 1/3N lithium batteries – Black
69282	TLR-6 (GLOCK® 26/27/33) without laser – White LED – Includes (2) CR 1/3N lithium batteries – Black
69283	TLR-6 (M&P® Shield™) without laser – White LED – Includes (2) CR 1/3N lithium batteries – Black
69285	TLR-6 (SIG SAUER® P365®/XL) without laser – White LED – Includes (2) CR 1/3N lithium batteries – Black

All rights reserved. GLOCK®, Smith & Wesson® and M&P SHIELD®, Kahr®, SIG SAUER®, Kimber®, Springfield Armory®, Taurus®, Colt®, and Remington® are registered trademarks of Glock, Inc., Smith & Wesson Inc., Saeilo Enterprises, Inc., SIG Sauer, Inc., Kimber IP, LLC, Springfield, Inc., Taurus Armas S.A., Colt's Manufacturing IP Holding Company LLC, and Ammunition Operations, LLC, respectively. Streamlight has not sought endorsement from any of the Companies mentioned in this paragraph.

Red Laser #69270
GLOCK® 42/43



Red Laser #69278
GLOCK® 42/43



Red Laser #69272
GLOCK® 26/27/33



Red Laser #69273
M&P® Shield™ 40/9



Red Laser #69284
SIG SAUER® P365®/XL



Red Laser #69286
GLOCK® 43X/48MOS
GLOCK® 43X/48Rail



Red Laser #69288
Taurus GX4™



Non Laser #69280
GLOCK® 42/43



Non Laser #69282
GLOCK® 26/27/33



Non Laser #69283
M&P® Shield™ 40/9



Non Laser #69285
SIG SAUER® P365®/XL



Red Laser #69287
SA Hellcat®





TLR-6 HL[®]

RECHARGEABLE LIGHTS FOR COMPACT, SUBCOMPACT & CONCEALED CARRY WEAPONS

TLR-6 HL[®] // TLR-6 HL[®] G RAIL MOUNT **NEW**

With a rechargeable battery system powering 300 lumens of bright light and a red or green laser, identifying the target has never been easier. Includes three easy-to-swap batteries to triple your runtime for a full hour of power. A portable charging case conveniently stores and charges your batteries without the need to tether your gun. Save on cost over disposable batteries and save the waste stream. Durable, Impact-resistant polymer construction. Designed to securely attach to the rail and the trigger guard of GLOCK[®] compact railed handguns, standard and compact railed handguns.

BATTERY: (1) SL-B2[®] rechargeable battery
SIZE: 2.50" x 0.85" x 1.56" (6.35 x 2.16 x 3.96 cm)
Size & Weight vary by model
WEIGHT: 1.12 oz. (31.8g)
COLORS: Black

LUMENS:	300
CANDELA:	4,250
DISTANCE:	130m
RUN TIME:	20min
RED LASER: RUNS 9 HOURS	
GREEN LASER: RUNS 5 HOURS	



Red Laser #69343
GLOCK[®] Rail Mount



Green Laser #69353
GLOCK[®] Rail Mount

ITEM #	DESCRIPTION
69343	TLR-6 HL (GLOCK [®] Rail Mount) White LED/red laser – Includes (3) SL-B2 batteries and charger
69353	TLR-6 HL G (GLOCK [®] Rail Mount) White LED/green laser – Includes (3) SL-B2 batteries and charger

TLR-6 HL® FOR SUBCOMPACT HANDGUNS **NEW**

With a rechargeable battery system powering 300 lumens of bright light and a red or green laser, identifying the target has never been easier. Includes three easy-to-swap batteries to triple your runtime for a full hour of power. A portable charging case conveniently stores and charges your batteries without the need to tether your gun. Save on cost over disposable batteries and save the waste stream. Durable, Impact-resistant polymer construction. Designed to securely attach to the trigger guard/rail of select handguns.

BATTERY: (1) SL-B2® rechargeable battery
SIZE: 2.50" x 0.85" x 1.56" (6.35 x 2.16 x 3.96 cm)
Size & Weight vary by model
WEIGHT: 1.12 oz. (31.8g)
COLORS: Black or Flat Dark Earth

LUMENS:	300
CANDELA:	4,250
DISTANCE:	130m
RUN TIME:	20min
RED LASER: RUNS 9 HOURS	
GREEN LASER: RUNS 5 HOURS	

SL-B2® charging case

Charges batteries using USB-C cord
 Features charge status indicator

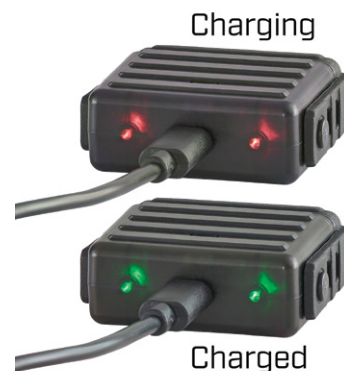

Red Laser #69340
GLOCK® 42/43/49



Red Laser #69341
GLOCK® 42/43/49



Red Laser #69342
M&P® Shield™ 40/9



Red Laser #69344
SIG SAUER® P365®/XL



Green Laser #69350
GLOCK® 42/43/49



Green Laser #69351
GLOCK® 42/43/49



Green Laser #69352
M&P® Shield™ 40/9



Green Laser #69354
SIG SAUER® P365®/XL



ITEM #	DESCRIPTION
TLR-6 HL	
69340	TLR-6 HL (GLOCK® 42/43/49) White LED/red laser – Includes (3) SL-B2 batteries and charger - Black
69341	TLR-6 HL (GLOCK® 42/43/49) White LED/red laser – Includes (3) SL-B2 batteries and charger - Flat Dark Earth
69342	TLR-6 HL (M&P® Shield™ 40/9) White LED/red laser – Includes (3) SL-B2 batteries and charger - Black
69344	TLR-6 HL (SIG SAUER® P365®/XL) White LED/red laser – Includes (3) SL-B2 batteries and charger - Black
TLR-6 HL G	
69350	TLR-6 HL G (GLOCK® 42/43/49) White LED/green laser – Includes (3) SL-B2 batteries and charger - Black
69351	TLR-6 HL G (GLOCK® 42/43/49) White LED/green laser – Includes (3) SL-B2 batteries and charger - Flat Dark Earth
69352	TLR-6 HL G (M&P® Shield™ 40/9) White LED/green laser – Includes (3) SL-B2 batteries and charger - Black
69354	TLR-6 HL G (SIG SAUER® P365®/XL) White LED/green laser – Includes (3) SL-B2 batteries and charger - Black

All rights reserved. GLOCK® is a registered trademark of Glock, Inc. SIG SAUER® and P365® are registered trademarks of SIG Sauer, Inc. M&P® Shield™ is a trademark of Smith & Wesson Inc. Streamlight has not sought endorsement from any of the Companies mentioned in this paragraph.

TLR-7[®] X RAIL MOUNTED LIGHT

WHITE LIGHT ILLUMINATOR / TWO SWITCH POSITION OPTIONS

The TLR series is going rechargeable! The TLR-7 X multi-fuel rail-mounted light accepts either our new SL-B9[®] USB rechargeable protected lithium-ion battery pack or a CR123A lithium battery. Interchangeable rear paddle switches accommodate your shooting style.

BATTERY: (1) SL-B9 rechargeable battery pack or (1) CR123A lithium battery
SIZE: 2.58" x 1.18" x 1.27" (6.55 x 2.98 x 3.23 cm)
WEIGHT: 2.64 oz. (74.8g) w/SL-B9 // 2.48 oz. (70.3g) w/CR123A
COLOR: Black or FDE

LUMENS:	500
CANDELA:	5,000
DISTANCE:	140m
RUN TIME (SL-B9):	1h
RUN TIME (CR123A):	1.5h



[(STROBE)]
 Double tap
 switch to activate

Safe Off feature prevents
 accidental activation;
 saves batteries

ITEM #	DESCRIPTION
69424	TLR-7 X – Includes high switch mounted on light plus low switch in package – lithium battery, key kit – Black
69429	TLR-7 X – Includes high switch mounted on light plus low switch in package – lithium battery, key kit – FDE
69455	TLR-7 X USB – Includes high switch mounted on light plus low switch in package – SL-B9 rechargeable battery pack, key kit – Black
69456	TLR-7 X USB – Includes high switch mounted on light plus low switch in package – SL-B9 rechargeable battery pack, key kit – FDE



MULTI-FUEL DESIGN:
 Runs on SL-B9
 battery pack or
 CR123A battery



Interchangeable paddle switches
 easy to swap out with multi-tool
 (included)

TLR-7[®] X CONTOUR REMOTE RAIL MOUNTED LIGHT

WHITE LIGHT ILLUMINATOR / HIGH SWITCH POSITION

The TLR-7 X Contour Remote is designed for one-handed shooting - ideal for dog handlers, SWAT teams, door breaching and close quarter operations. IPX7-rated; waterproof to 1m for 30 minutes.

BATTERY: (1) CR123A lithium
SIZE: 4.6" x 1.16" x 1.79" (11.68 x 2.95 x 4.55 cm)
WEIGHT: 2.85 oz. (80.7g) w/SL-B9 // 2.69 oz. (76.3g) w/CR123A
COLOR: Black

LUMENS:	500
CANDELA:	5,000
DISTANCE:	140m
RUN TIME (SL-B9):	1h
RUN TIME (CR123A):	1.5h



Safe Off feature prevents
 accidental activation;
 saves batteries



Securely fits GLOCK[®] Gen 4 or Gen 5 models with rails or SIG SAUER[®] P320[®] XCARRY frame. Designed to fit snugly around the trigger guard.

Note: Cannot be retrofitted with existing TLR-7 X products

ITEM #	DESCRIPTION
69428	TLR-7 X Contour Remote - for GLOCK [®] Gen 4 or Gen 5 models, CR123A lithium battery
69480	TLR-7 X Contour Remote - for SIG SAUER [®] P320 [®] XCARRY frame, CR123A lithium battery



TLR-7® HL-X USB RAIL MOUNTED LIGHT // **NEW**

WHITE LIGHT ILLUMINATOR / TWO SWITCH POSITION OPTIONS

The TLR-7 HL-X USB, high lumen, multi-fuel rail-mounted light accepts either our new SL-B9® USB rechargeable protected lithium-ion battery pack or a CR123A lithium battery. Interchangeable rear paddle switches accommodate your shooting style. Face cap engineered to produce a longer reaching, tighter beam. User-programmable output modes. IPX7-rated; waterproof to 1m for 30 minutes.

BATTERY: (1) SL-B9 rechargeable battery pack or (1) CR123A lithium battery
SIZE: 2.9" x 1.18" x 1.27" (7.37 x 2.98 x 3.23 cm)
WEIGHT: 2.88 oz. (81.6g) w/ SL-B9 // 2.8 oz. (79.4g) w/ CR123A
COLOR: Black or Flat Dark Earth

SL-B9	
LUMENS:	1,000
CANDELA:	22,000
DISTANCE:	297m
RUN TIME:	30 min
CR123A	
LUMENS:	500
CANDELA:	11,000
DISTANCE:	210m
RUN TIME:	1.5h

[(STROBE)]

Double tap switch to activate



Safe Off feature prevents accidental activation; saves batteries

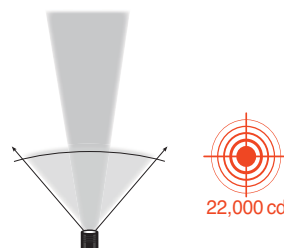

MULTI-FUEL DESIGN:

Runs on SL-B9 battery pack or CR123A battery

ITEM #	DESCRIPTION
69458	TLR-7 HL-X USB – Includes high switch mounted on light plus low switch in package, SL-B9 rechargeable battery pack and key kit – Black
69459	TLR-7 HL-X USB – Includes high switch mounted on light plus low switch in package, SL-B9 rechargeable battery pack and key kit – FDE



Interchangeable paddle switches easy to swap out with multi-tool (included)

STREAMLIGHT
TLR SERIES



TLR-8[®]A RAIL MOUNTED LIGHT

WHITE LIGHT ILLUMINATOR / **RED LASER** / TWO SWITCH POSITION OPTIONS

The TLR-8A features an integrated 640-660nm red laser and customized ergonomic switches featuring a low or high position to match your shooting style. It features an ambidextrous on/off switch and a rail clamp designed to rapidly attach/detach from the side of compact and full frame weapons. IPX4-rated; water-resistant.

BATTERY: (1) CR123A lithium
SIZE: 2.58" x 1.18" x 1.5" (6.55 x 2.98 x 3.81 cm)
WEIGHT: 2.64 oz. (75g)
COLOR: Black

LUMENS:	500
CANDELA:	5,000
DISTANCE:	140m
RUN TIME:	1.5h
LASER MODE: RUNS 60 HOURS	



ITEM #	DESCRIPTION
69414	TLR-8A – Includes high switch mounted on light plus low switch in package, lithium battery and key kit

TLR-8[®]A G RAIL MOUNTED LIGHT

WHITE LIGHT ILLUMINATOR / **GREEN LASER** / TWO SWITCH POSITION OPTIONS

The TLR-8A G with an integrated 510-530nm green laser includes customized ergonomic switches featuring a low or high option to match your shooting style. It features an ambidextrous on/off switch and a rail clamp designed to rapidly attach/detach from side of compact and full frame weapons. IPX4-rated; water-resistant.

BATTERY: (1) CR123A lithium
SIZE: 2.58" x 1.18" x 1.5" (6.55 x 2.98 x 3.81 cm)
WEIGHT: 2.64 oz. (75g)
COLOR: Black

LUMENS:	500
CANDELA:	5,000
DISTANCE:	140m
RUN TIME:	1.5h
LASER MODE: RUNS 11 HOURS	

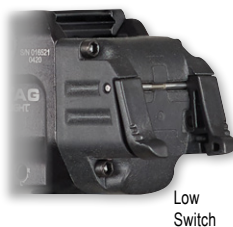

ITEM #	DESCRIPTION
69434	TLR-8A G – Includes high switch mounted on light plus low switch in package, lithium battery and key kit

[[STROBE]]

Double tap switch to activate



Safe Off feature prevents accidental activation; saves batteries



Interchangeable paddle switches easy to swap out with multi-tool (included)

[[STROBE]]

Double tap switch to activate



Safe Off feature prevents accidental activation; saves batteries

TLR-7® HL-X SUB RAIL MOUNTED LIGHT **NEW**

WHITE LIGHT ILLUMINATOR / HIGH SWITCH POSITION

Level up with the TLR-7 HL-X sub! This multi-fuel rail-mounted light uses Streamlight's SL-B9 USB rechargeable protected lithium-ion battery pack or a CR123A lithium battery. Its front-loading battery compartment makes it easy to quickly replace batteries while the light is still mounted to the firearm. Interchangeable paddle switches accommodate your shooting style. Constructed of durable, anodized aluminum, it's waterproof to 1 meter for 30 minutes. The ultra-compact and lightweight TLR-7 X sub fits on select railed subcompact pistols.

BATTERY: (1) SL-B9 rechargeable battery pack or (1) CR123A lithium battery
SIZE: 1.16" x 1.24" x 2.51" (2.95 x 3.15 x 6.38 cm)
WEIGHT: 2.49 oz. (70.6g) w/ SL-B9 // 2.39 oz. (67.8g) w/ CR123A
COLOR: Black

ITEM #	DESCRIPTION
69503	TLR-7 HL-X sub USB (GLOCK® 43X/48 MOS 43X/48 Rail) - Includes mounting kit with key, multi-tool and (1) SL-B9 Li-ion rechargeable battery pack and USB-C cord
69504	TLR-7 HL-X sub USB (SIG SAUER® P365®/XL closed rail systems*) - Includes mounting kit with key, multi-tool and (1) SL-B9 Li-ion rechargeable battery pack and USB-C cord *Does not fit the P365® XMACRO
69505	TLR-7 HL-X sub USB (1913 short) - Includes mounting kit with key, multi-tool and (1) SL-B9 Li-ion rechargeable battery pack and USB-C cord
69506	TLR-7 HL-X sub USB (Springfield Armory® Hellcat®) - Includes mounting kit with key, multi-tool and (1) SL-B9 Li-ion rechargeable battery pack and USB-C cord

SL-B9	DEFAULT	PROGRAMMABLE
LUMENS:	1,000	500
CANDELA:	10,000	5,000
DISTANCE:	200m	141m
RUN TIME:	30 min	1h

CR123A
LUMENS: 500
CANDELA: 5,000
DISTANCE: 141m
RUN TIME: 1.5h

[(STROBE)]

Double tap switch to activate



Safe Off feature prevents accidental activation; saves batteries



1,000 LUMENS



Interchangeable paddle switches easy to swap out with multi-tool (included)

TLR-7® X SUB RAIL MOUNTED LIGHT

WHITE LIGHT ILLUMINATOR / HIGH SWITCH POSITION

Maximize your weapons platform with interchangeable paddle switches that allow you to customize your TLR-7 X sub to your shooting style. This multi-fuel rail-mounted light uses Streamlight's SL-B9 USB rechargeable protected lithium-ion battery pack or a CR123A lithium battery. Its front-loading battery compartment makes it easy to quickly replace batteries while the light is still mounted to the firearm. Designed to enhance visibility and targeting capability in home defense and tactical situations, the ultra-compact and lightweight TLR-7 X sub fits on select railed subcompact pistols. IPX7-rated; waterproof to 1m for 30 minutes.

BATTERY: (1) SL-B9 rechargeable battery pack or (1) CR123A lithium battery
SIZE: 1.16" x 1.24" x 2.51" (2.95 x 3.15 x 6.38 cm)
WEIGHT: 2.39 oz. (67.8g)
COLOR: Black

LUMENS:	500
CANDELA:	5,000
DISTANCE:	142m
RUN TIME [CR123A]:	1.5h
RUN TIME [SLB9]:	1h

[(STROBE)]

Double tap switch to activate



Safe Off feature prevents accidental activation; saves batteries



Interchangeable paddle switches easy to swap out with multi-tool (included)

ITEM #	DESCRIPTION
69400	TLR-7 X sub (for GLOCK® 43X/48 MOS 43X/48 Rail models only) - Includes mounting kit with key & CR123A lithium battery
69401	TLR-7 X sub (for Sig Sauer® P365®/XL closed rail systems) - Includes mounting kit with key and CR123A lithium battery <i>Does not fit the P365® XMACRO</i>
69402	TLR-7 X sub (for 1913 short models) - Includes mounting kit with keys and CR123A lithium battery
69404	TLR-7 X sub (for Hellcat®) - Includes mounting kit with keys and CR123A lithium battery

ITEM #	DESCRIPTION
69405	TLR-7 X sub USB (GLOCK® 43X/48 MOS 43X/48 Rail) - Includes mounting kit with key, multi-tool, SL-B9 battery pack and USB-C cord
69406	TLR-7 X sub USB (for Sig Sauer® P365®/XL closed rail systems) - Includes mounting kit with key, multi-tool, SL-B9 battery pack and USB-C cord <i>Does not fit the P365® XMACRO</i>
69407	TLR-7 X sub USB (1913 short) - Includes mounting kit with keys, multi-tool, SL-B9 battery pack and USB-C cord
69408	TLR-7 X sub USB (for Hellcat®) - Includes mounting kit with key, multi-tool, SL-B9 battery pack and USB-C cord

TLR-8® SUB RAIL MOUNTED LIGHT

WHITE LIGHT ILLUMINATOR / **RED LASER** / HIGH SWITCH POSITION

Maximize your weapons platform with interchangeable rear paddle switches that allow you to customize your TLR-8 sub to your shooting style. Designed to enhance visibility and targeting capability in home defense and tactical situations, the ultra-compact and lightweight TLR-8 sub fits on select railed subcompact pistols. IPX4-rated; water-resistant.

LUMENS: 500
CANDELA: 5,000
DISTANCE: 141m
RUN TIME: 1.5h
LASER MODE: RUNS 60 HOURS

[(STROBE)]
Double tap
switch to activate



Safe Off feature prevents accidental activation; saves batteries

BATTERY: (1) CR123A lithium
SIZE: 2.51" x 1.16" x 1.45" (6.38 x 2.95 x 3.68 cm)
WEIGHT: 2.77 oz. (78.53g)
COLOR: Black



Interchangeable paddle switches easy to swap out with multi-tool (included)



ITEM #	DESCRIPTION
69411	TLR-8 sub (for GLOCK® 43X/48 MOS 43X/48 Rail models only) - Includes mounting kit with key and CR123A lithium battery
69417	TLR-8 sub (for SIG SAUER® P365®/XL closed rail systems) – Includes mounting kit with key and CR123A lithium battery
69418	TLR-8 sub (for 1913 short models) – Includes mounting kit with keys and CR123A lithium battery
69419	TLR-8 sub (for SA® Hellcat®) - Includes mounting kit with keys and CR123A lithium battery

TLR-8® G SUB RAIL MOUNTED LIGHT

WHITE LIGHT ILLUMINATOR / **GREEN LASER** / HIGH SWITCH POSITION

Maximize your weapons platform with interchangeable rear paddle switches that allow you to customize your TLR-8 G sub to your shooting style. Designed to enhance visibility and targeting capability in home defense and tactical situations, the ultra-compact and lightweight TLR-8 G sub fits on select railed subcompact pistols. IPX4-rated; water-resistant.

LUMENS: 500
CANDELA: 5,000
DISTANCE: 141m
RUN TIME: 1.5h
LASER MODE: RUNS 11 HOURS

[(STROBE)]
Double tap
switch to activate



Safe Off feature prevents accidental activation; saves batteries

BATTERY: (1) CR123A lithium
SIZE: 2.51" x 1.16" x 1.45" (6.38 x 2.95 x 3.68 cm)
WEIGHT: 2.77 oz. (78.53g)
COLOR: Black



Interchangeable paddle switches easy to swap out with multi-tool (included)

ITEM #	DESCRIPTION
69431	TLR-8 G sub (for GLOCK® 43X/48 MOS 43X/48 Rail models only) - Includes mounting kit with key and CR123A lithium battery
69437	TLR-8 G sub (for SIG SAUER® P365®/XL closed rail systems) – Includes mounting kit with key and CR123A lithium battery
69438	TLR-8 G sub (for 1913 short models) – Includes mounting kit with keys and CR123A lithium battery
69439	TLR-8 G sub (for SA® Hellcat®) - Includes mounting kit with keys and CR123A lithium battery

TLR-9[®] RAIL MOUNTED LIGHT

WHITE LIGHT ILLUMINATOR / TWO SWITCH POSITION OPTIONS

Maximize your weapons platform with interchangeable rear paddle switches that allow you to customize your TLR-9 to your shooting style. It features a rail clamp that is designed to rapidly attach/detach from full frame weapons. IPX7-rated; waterproof to 1m for 30 minutes.

BATTERY: (2) CR123A lithium
SIZE: 3.87" x 1.18" x 1.27" (9.82 x 2.98 x 3.22 cm)
WEIGHT: 4.26 oz. (120.9g)
COLOR: Black

LUMENS:	1,000
CANDELA:	10,000
DISTANCE:	200m
RUN TIME:	1.5h
STROBE: RUNS 3 HOURS	

**1,000
LUMENS**

[(STROBE)]
 Double tap
 switch to activate



Safe Off feature prevents accidental activation; saves batteries



High Switch



Low Switch



Interchangeable paddle switches easy to swap out with multi-tool (included)

ITEM #	DESCRIPTION
69464	TLR-9 – Includes high switch mounted on light plus low switch in package, lithium batteries and key kit



TLR-10[®] RAIL MOUNTED LIGHT

WHITE LIGHT ILLUMINATOR / **RED LASER** / TWO SWITCH POSITION OPTIONS

Maximize your weapons platform with interchangeable rear paddle switches that allow you to customize your TLR-10 with an integrated 640-660nm red laser to your shooting style. It features a rail clamp that is designed to rapidly attach/detach from full frame weapons. IPX4-rated; water-resistant.

BATTERY: (2) CR123A lithium
SIZE: 3.87" x 1.18" x 1.50" (9.82 x 2.98 x 3.81 cm)
WEIGHT: 4.62 oz. (131g)
COLOR: Black

LUMENS:	1,000
CANDELA:	10,000
DISTANCE:	200m
RUN TIME:	1.5h
LASER MODE: RUNS 60 HOURS	



High Switch



Low Switch

ITEM #	DESCRIPTION
69470	TLR-10 – Includes high switch mounted on light plus low switch in package, lithium batteries and key kit



**1,000
LUMENS**

[(STROBE)]

Double tap switch to activate



Safe Off feature prevents accidental activation; saves batteries



Interchangeable paddle switches easy to swap out with multi-tool (included)

TLR-10[®] G RAIL MOUNTED LIGHT

WHITE LIGHT ILLUMINATOR / **GREEN LASER** / TWO SWITCH POSITION OPTIONS

Maximize your weapons platform with interchangeable rear paddle switches that allow you to customize your TLR-10 G with an integrated 510-530nm green laser to match your shooting style. It features a rail clamp that is designed to rapidly attach/detach from full frame weapons. IPX4-rated; water-resistant.

BATTERY: (2) CR123A lithium
SIZE: 3.87" x 1.18" x 1.50" (9.82 x 2.98 x 3.81 cm)
WEIGHT: 4.62 oz. (131g)
COLOR: Black

LUMENS:	1,000
CANDELA:	10,000
DISTANCE:	200m
RUN TIME:	1.5h
LASER MODE: RUNS 11 HOURS	



High Switch



Low Switch

ITEM #	DESCRIPTION
69473	TLR-10 G – Includes high switch mounted on light plus low switch in package, lithium batteries and key kit



**1,000
LUMENS**

[(STROBE)]

Double tap switch to activate



Safe Off feature prevents accidental activation; saves batteries

STREAMLIGHT



STREAMLIGHT

TLR-7[®] X

MULTI-FUEL: SL-B9 RECHARGEABLE OR CR123A |
HIGH AND LOW SWITCH OPTIONS | 500 LUMENS

[STREAMLIGHT.COM/TLR-7X](https://streamlight.com/TLR-7X)
©2024 STREAMLIGHT, INC. ALL RIGHTS RESERVED.

STREAMLIGHT

SL-B9[®] BATTERY PACK

TURN YOUR TLRs INTO RECHARGEABLE SYSTEMS



You know how you make the best performing gun lights in the business even better? Simple. Give users multiple ways to power and charge them. Introducing our SL-B9[®] Protected Lithium-ion USB Rechargeable Battery Pack with integrated charging port. Charges by USB cord, or optional bank charger. Flexibility for however and wherever you use your light.

SL-B9[®] PROTECTED LITHIUM-ION USB RECHARGEABLE BATTERY PACK NEW

The battery pack that transforms multi-fuel, high-performance gun lights into rechargeable systems. USB rechargeable - Features USB-C input and charge status indicators; charges in 2.5 hours. Integrated safety circuit protects battery from overcharge. Charge via USB source or optional bank charger for departmental use. The charge cradle is ideal for storage as well as to charge your batteries.

BATTERY CAPACITY: 850mAh SL-B9 protected Li-Ion USB rechargeable battery pack
BATTERY SIZE: 1.36" x 0.67" (3.45 x 1.7 cm)
BATTERY WEIGHT: 0.72 oz. (20.4g)

ITEM #	DESCRIPTION
20237	SL-B9 Li-Ion USB rechargeable battery pack- 2Pk
20238	SL-B9 Li-Ion USB rechargeable battery pack- 8Pk
22084	22" (55.88 cm) USB-C Cord



Features integrated USB port.
 Charge status LEDs:

Red = charging

Green = charged



USB-C Rechargeable 850mAh SL-B9 Lithium-Ion Battery Pack — Charges in 2.5 hours.

STREAMLIGHT

SPEEDLOCKER®

PERSONAL, PORTABLE STORAGE | AIR
TRAVEL SUITABLE WITH SUPPLIED PADLOCK |
CONVENIENT CARRY HANDLE



[STREAMLIGHT.COM/SPEEDLOCKER](https://streamlight.com/speedlocker)
©2024 STREAMLIGHT, INC. ALL RIGHTS RESERVED

STREAMLIGHT

SPEEDLOCKER®

The SpeedLocker is a portable, locking storage container that provides you with swift and direct access. A patented mechanical keypad with one-handed entry keeps your personal items secure at home or at work. Rugged, water-resistant construction with convenient carry handle is designed for travel making it an ideal companion wherever you go.

The SpeedLocker accommodates various firearm sizes. It's important to note that the SpeedLocker is not a gun safe; however, it effectively limits unauthorized access while ensuring your essentials remain within easy reach.

EXTERNAL: 12.4" x 8.2" x 2.78" (31.5 x 20.8 x 7.1 cm)

INTERNAL: 8" x 7.1" (20.3 x 18 cm)

WEIGHT: 2.6 lbs. (1.2 kg)

COLOR: Black



ITEM #	DESCRIPTION
59000	SpeedLocker - Includes padlock with keys, Allen key and security cable
59001	Padlock with 3 keys
59002	3' (91.44 cm) Security Cable

The SpeedLocker® is not an approved firearm safe. It is the user responsibility to determine the suitability to the specific situation and need.



Patented mechanical keypad with 31 user selectable combinations - requires no batteries



Fits various compact firearm models



Air travel suitable with supplied padlock



TLR[®] RM 1

COMPACT RAIL MOUNTED LIGHTING SYSTEM

The low-profile TLR RM 1 features an HPL face cap for a longer reaching, tighter beam; provides increased candela while maintaining the lumen output. Independently operating push-button and remote pressure switches provide the security of knowing you'll always have light. IPX7-rated; waterproof to 1 meter for 30 minutes. System is packaged as a kit offering everything you need to mount to your long gun.

BATTERY: (1) CR123A lithium
SIZE: 3.64" x 1.5" x 1.18" (9.25 x 3.81 x 3 cm)
WEIGHT: 3.02 oz. (85.6g)
COLOR: Black

LUMENS:	500
CANDELA:	11,000
DISTANCE:	210m
RUN TIME:	1.5h
STROBE RUNS 3 HOURS	

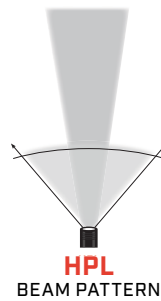

[(STROBE)]

Double tap
switch to activate



Safe Off feature prevents
accidental activation; saves batteries

ITEM #	DESCRIPTION
69440	TLR RM 1 - System - Includes remote door switch, remote pressure switch, mounting clips and CR123A lithium battery
69441	TLR RM 1 - Light Only - Includes key kit and (1) CR123A lithium battery
69442	TLR RM 1 - with Dual Remote Switch



TLR RM 1 with Remote
Pressure Switch: #69440

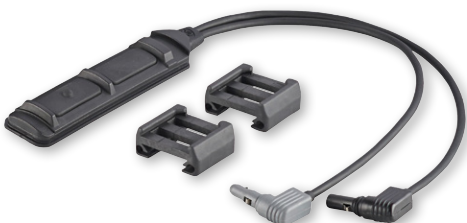

#69138 - TLR Dual Remote Pressure Switch, Mounting Clips,
Adhesive pad, and Cable Ties:

Accessory switch allows for simultaneous or individual activation of the Streamlight TLR-1 & 2 / TLR RM 1 & 2 / TLR RM 1 & 2 Laser Weapon lights (sold separately) and accompanying external aiming device

COMPACT RAIL MOUNTED LONG GUN LIGHTING SYSTEMS

TLR[®] RM 2

COMPACT RAIL MOUNTED LIGHTING SYSTEM

The low-profile TLR RM 2 features an HPL face cap for a longer reaching, tighter beam; provides increased candela while maintaining the lumen output. Independently operating push-button and remote pressure switches provide the security of knowing you'll always have light. IPX7-rated; waterproof to 1 meter for 30 minutes. System is packaged as a kit offering everything you need to mount to your long gun.

BATTERY: (2) CR123A lithium
SIZE: 4.97" x 1.5" x 1.18" (12.6 x 3.81 x 3 cm)
WEIGHT: 4.68 oz. (132.7g)
COLOR: Black

LUMENS:	1,000
CANDELA:	22,000
DISTANCE:	297m
RUN TIME:	1.5h
STROBE RUNS 3 HOURS	

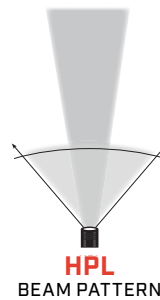

[(STROBE)]

Double tap
switch to activate



Safe Off feature prevents
accidental activation; saves batteries

ITEM #	DESCRIPTION
69450	TLR RM 2 - System - Includes remote door switch, remote pressure switch, mounting clips, & (2) CR123A lithium batteries
69451	TLR RM 2 - Light Only - Includes Key Kit and (2) CR123A lithium batteries



TLR RM 2 with Remote
Pressure Switch: #69450

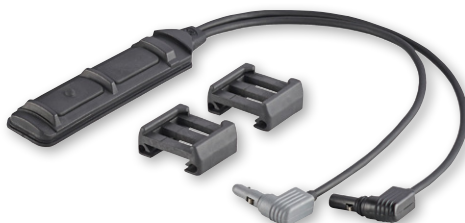

#69138 - TLR Dual Remote Pressure Switch, Mounting Clips,
Adhesive pad, and Cable Ties:

Accessory switch allows for simultaneous or individual activation of the Streamlight TLR-1 & 2 / TLR RM 1 & 2 / TLR RM 1 & 2 Red & Green Laser models Weapon lights (sold separately) and accompanying external aiming device

STREAMLIGHT LONG GUN LIGHT SERIES

TLR[®] RM 1 LASER COMPACT, HIGH CANDELA RAIL MOUNTED LIGHTING SYSTEM

WHITE LIGHT ILLUMINATOR / RED LASER

The low-profile TLR RM 1 Laser features an HPL face cap for a longer reaching, tighter beam. It's designed to provide increased candela while maintaining the lumen output. Independently operating push-button and remote pressure switches provide the security of knowing you'll always have light. IPX4-rated; water-resistant 1m impact resistance tested. System is packaged as a kit offering everything you need to mount to your long gun.

BATTERY: (1) CR123A lithium
SIZE: 3.64" x 1.5" x 1.18" (9.25 x 3.81 x 3 cm)
WEIGHT: 3.24 oz. (91.9g)
COLOR: Black

LUMENS: 500
CANDELA: 11,000
DISTANCE: 210m
RUN TIME: 1.5h
 STROBE RUNS 3 HOURS
 LASER RUNS 60 HOURS

ITEM #	DESCRIPTION
69445	TLR RM 1 Laser - System - Includes remote door switch, remote pressure switch, mounting clips and (1) CR123A lithium battery
69446	TLR RM 1 Laser - Light Only - Includes key kit and (1) CR123A lithium battery

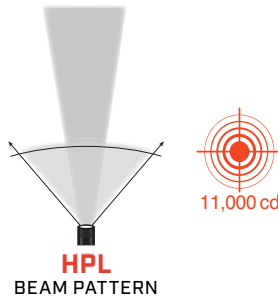

[(STROBE)]
Double tap
switch to activate



Safe Off feature prevents accidental activation; saves batteries

TLR[®] RM 2 LASER COMPACT, HIGH CANDELA RAIL MOUNTED LIGHTING SYSTEM

WHITE LIGHT ILLUMINATOR / RED LASER

The low-profile TLR RM 2 Laser features an HPL face cap for a longer reaching, tighter beam. It's designed to provide increased candela while maintaining the lumen output. Independently operating push-button and remote pressure switches provide the security of knowing you'll always have light. IPX4-rated; water-resistant 1m impact resistance tested. System is packaged as a kit offering everything you need to mount to your long gun.

BATTERY: (2) CR123A lithium
SIZE: 4.97" x 1.18" x 1.5" (12.6 x 3 x 3.81 cm)
WEIGHT: 5.11 oz. (144.7g)
COLOR: Black

LUMENS: 1,000
CANDELA: 22,000
DISTANCE: 297m
RUN TIME: 1.5h
 STROBE RUNS 3 HOURS
 LASER RUNS 60 HOURS

ITEM #	DESCRIPTION
69447	TLR RM 2 Laser - System - Includes remote door switch, remote pressure switch, mounting clips and (2) CR123A lithium batteries
69448	TLR RM 2 Laser - Light Only - Includes key kit and (2) CR123A lithium batteries

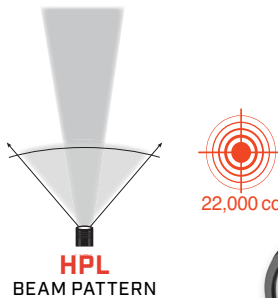

[(STROBE)]
Double tap
switch to activate



Safe Off feature prevents accidental activation; saves batteries



#69138 – TLR Dual Remote Pressure Switch, Mounting Clips, Adhesive pad, and Cable Ties:

Accessory switch allows for simultaneous or individual activation of the Streamlight TLR-1 & 2 / TLR RM 1 & 2 / TLR RM 1 & 2 Red & Green Laser models
 Weapon lights (sold separately) and accompanying external aiming device

TLR[®] RM 1 LASER-G COMPACT, HIGH CANDELA RAIL MOUNTED LIGHTING SYSTEM
WHITE LIGHT ILLUMINATOR / GREEN LASER

The low-profile TLR RM 1 Laser-G features an HPL face cap for a longer reaching, tighter beam. It is designed to provide increased candela while maintaining the lumen output. Independently operating push-button and remote pressure switches provide the security of knowing you'll always have light. IPX4-rated; water-resistant 1m impact resistance tested. System is packaged as a kit offering everything you need to mount to your long gun.

BATTERY: (1) CR123A lithium
SIZE: 3.64" x 1.5" x 1.18" (9.25 x 3.81 x 3 cm)
WEIGHT: 3.24 oz. (91.9g)
COLOR: Black

LUMENS:	500
CANDELA:	11,000
DISTANCE:	210m
RUN TIME:	1.5h
STROBE RUNS 3 HOURS LASER RUNS 60 HOURS	

ITEM #	DESCRIPTION
69443	TLR RM 1 Laser-G - System - Includes remote door switch, remote pressure switch, mounting clips and CR123A lithium battery
69444	TLR RM 1 Laser-G - Light Only - Includes key kit & (1) CR123A lithium battery

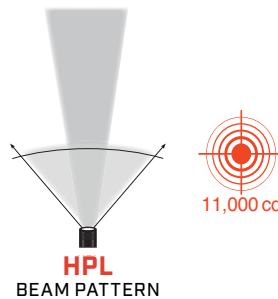

[[STROBE]]
Double tap
switch to activate

Safe Off feature prevents
accidental activation;
saves batteries



Remote pressure switch attaches with retaining clips

TLR[®] RM 2 LASER-G COMPACT, HIGH CANDELA RAIL MOUNTED LIGHTING SYSTEM
WHITE LIGHT ILLUMINATOR / GREEN LASER

The low-profile TLR RM 2 Laser-G features an HPL face cap for a longer reaching, tighter beam. It is designed to provide increased candela while maintaining the lumen output. Independently operating push-button and remote pressure switches provide the security of knowing you'll always have light. IPX4-rated; water-resistant 1m impact resistance tested. System is packaged as a kit offering everything you need to mount to your long gun.

BATTERY: (2) CR123A lithium
SIZE: 4.97" x 1.18" x 1.5" (12.6 x 3 x 3.81 cm)
WEIGHT: 5.11 oz. (144.7g)
COLOR: Black

LUMENS:	1,000
CANDELA:	22,000
DISTANCE:	297m
RUN TIME:	1.5h
STROBE RUNS 3 HOURS LASER RUNS 60 HOURS	

ITEM #	DESCRIPTION
69453	TLR RM 2 Laser-G - System - Includes remote door switch, remote pressure switch, mounting clips and (2) CR123A lithium batteries
69454	TLR RM 2 Laser-G - Light Only - Includes Key Kit and (2) CR123A lithium batteries

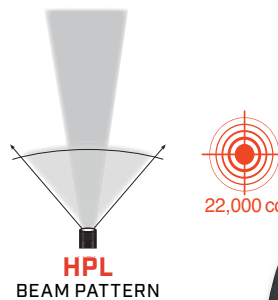

[[STROBE]]
Double tap
switch to activate

Safe Off feature prevents
accidental activation;
saves batteries

Remote switch exits port at 90° providing
improved wire routing to preserve rail space



Ergonomic push-button switch



Mode selector toggle switch for Laser only
Light only or Light/Laser combo

**STREAMLIGHT
LONG GUN LIGHT SERIES**

TLR-1 HPL[®]

HIGH-LUMEN + LONG-DISTANCE

SEE EVERYWHERE

TLR-1 HPL[®]

WHITE LIGHT ILLUMINATOR

This high lumen, long-range, rail-mounted tactical light produces an intensely bright, far-reaching wide beam that illuminates your target downrange along with everything in your path. Fits long-guns. Attaches/detaches with one hand in seconds. Includes a strobe for signaling/disorienting. IPX7-rated; waterproof to 1 meter for 30 minutes. Impact-resistant. Easy, fast battery replacement.

LUMENS:	1,000
CANDELA:	60,000
DISTANCE:	490m
RUN TIME:	1.5h

[(STROBE)]

Double tap switch to activate



TLR-1 HPL

BATTERY: (2) CR123A lithium
SIZE: 4.83" x 1.44" x 2.2"
(12.27 x 3.66 x 5.59 cm)
WEIGHT: 5.6 oz. (158.8g)
COLOR: Black

W/REMOTE

BATTERY: (2) CR123A lithium
SIZE: 5.25" x 1.44" x 2.2"
(13.34 x 3.66 x 5.59 cm)
WEIGHT: 5.9 oz. (167.3g)
COLOR: Black

ITEM #	DESCRIPTION
69215	TLR-1 HPL Standard Switch - Includes Rail Locating Keys for use with GLOCK [®] style, 1913 Picatinny, Smith & Wesson [®] 99/TSW and Beretta [®] 90-TWO - Lithium batteries
69216	TLR-1 HPL Remote Switch - Includes Rail Locating Keys for use with GLOCK [®] style, 1913 Picatinny, Smith & Wesson [®] 99/TSW and Beretta [®] 90-TWO - Remote switch - Lithium batteries
69219	TLR-1 HPL Long Gun Kit - Includes Safe Off remote door switch, remote pressure switch, mounting clips, standard door switch and lithium batteries



TL-RACKER®

The compact, lightweight all-in-one integrated shotgun forend light. Replace your weapon's forend with the TL-Racker featuring a bright 1,000 lumen LED light in a sleek design that eliminates the need for remote cords, reducing snag hazards. Its ergonomic design provides maximum grip and easy switch access for momentary and constant on. The elongated switch pad accommodates virtually any hand size. Uses two CR123A lithium batteries. Its customized optic produces a concentrated beam for multiple applications. Ideal for shotgun breaching, close quarter operations or elevating home defense options. IPX7-rated; waterproof to 1 meter for 30 minutes.

BATTERY: (2) CR123A lithium
SIZE: 8" x 1.95" x 2.64" (20.32 x 4.95 x 6.71 cm)
WEIGHT: 12.1 oz. (343g)
COLOR: Black or Orange

1,000
LUMENS

LUMENS:	1,000
CANDELA:	20,000
DISTANCE:	283m
RUN TIME:	1.5h



Mossberg 590®
Shockwave model



Models available for
Mossberg 500®/590®
and Remington 870™

ITEM #	DESCRIPTION
69600	TL Racker - Mossberg 500/590 - Includes (2) CR123A lithium batteries - Black
69601	TL Racker - Remington 870 - Includes (2) CR123A lithium batteries - Black
69602	TL Racker - Mossberg 590 Shockwave with strap - Includes (2) CR123A lithium batteries - Black
69610	TL Racker - Mossberg 500/590 - Includes (2) CR123A lithium batteries - Orange
69611	TL Racker - Remington 870 - Includes (2) CR123A lithium batteries - Orange

TLR SERIES ACCESSORIES

	TLR-1 HL/ TLR-2 HL	TLR-2 G/ TLR-2 HL G	TLR-1/ TLR-1s	TLR-2/ TLR-2s	TLR-VIR II	TLR-6	TLR-6 HL/ TLR-6 HL G
Remington 870 Mount 	69906	69906	69906	69906	—	—	—
TLR 12 ga. Mag Mount Mag Tube/Mossberg Rail 	69901 69903	69901 69903	69901 69903	69901 69903	—	—	—
Ambidextrous Vertical Grip w/Rail 	69114	69114	69114	69114	—	—	—
TLR-1/TLR-2 Key Kit 	69175	69175	69175	69175	—	—	—
TLR-7/TLR-8/TLR-9/TLR-10 Key Kit 	—	—	—	—	—	—	—
TLR M-LOK® Mount 	88301	88301	88301	88301	—	—	—
Contour Remote - GLOCK® - M&P® - SIG SAUER® P320® 	69300 69310 69481	69300 69310 69481	69300 69310 69481	69300 69310 69481	—	—	—
TLR-1/TLR-2 Remote Door Switch 	69130	69130	69130	69130	—	—	—
Door Switch w/Safe Off 	69161	69161	69161	69161	—	—	—
Tail Switch Kit - TLR-7 X/TLR-9 	—	—	—	—	—	—	—
Tail Switch Kit TLR-8A/8A G/TLR-10/10 G 	—	—	—	—	—	—	—
Tail Switch Kit TLR-7 sub 	—	—	—	—	—	—	—
Tail Switch Kit TLR-8 sub/TLR-8 G sub 	—	—	—	—	—	—	—
Tape Switch 	69132	69132	69132	69132	—	—	—
Coil Pressure Switch 	69134	69134	69134	69134	—	—	—
Straight Momentary Pressure Switch 	69135	69135	69135	69135	—	—	—
Straight Latching Pressure Switch 	89008	89008	89008	89008	—	—	—
Dual Remote Switch 	69138	69138	69138	69138	—	—	—
Remote Retaining Clips 	88178	88178	88178	88178	88178	—	—
Red Flip Lens Blue Flip Lens Green Flip Lens IR Flip Lens Opaque Flip Lens 	69115 69116 69117 69118 69124	69115 69116 69117 69118 69124	69115 69116 69117 69118 69124	69115 69116 69117 69118 69124	69115 69116 69117 69118 69124	—	—
CR123A Batteries 	2pk // 85175 6pk // 85180 12pk // 85177 400pk // 85179				—	—	—
CR1/3N Batteries 	—	—	—	—	—	69271 - 2pk 69281 - 12pk	—
SL-B9® Battery Pack 	—	—	—	—	—	—	—
SL-B2® Battery - 2pk 	—	—	—	—	—	—	22121
SL-B2® Charging Case 	—	—	—	—	—	—	22120

TLR-7 X USB/ TLR-7 X	TLR-7 HL-X USB	TLR-8A TLR-8A G	TLR-7 SUB	TLR-8 SUB TLR-8 G SUB	TLR-7X CONTOUR REMOTE	TLR-9	TLR-10 TLR-10 G	TLR RM 1 TLR RM 1 LASER RED/GREEN	TLR RM 2 TLR RM 2 LASER RED/GREEN	TLR-1 HPL
69906	69906	69906	—	—	—	69906	69906	—	—	69906
69901	69901	69901	—	—	—	69901	69901	—	—	69901 69903
—	—	—	—	—	—	—	—	—	—	69114
—	—	—	—	—	—	—	—	—	—	69175
69177	69177	69177	—	—	—	69177	69177	69177	69177	—
—	—	—	—	—	—	—	—	88301	88301	88301
—	—	—	—	—	—	—	—	—	—	—
—	—	—	—	—	—	—	—	—	—	69130
—	—	—	—	—	—	—	—	—	—	69161
69490	69490	—	—	—	—	69490	—	—	—	—
—	—	69491	—	—	—	—	69491	—	—	—
—	—	—	69492	—	—	—	—	—	—	—
—	—	—	—	69493	—	—	—	—	—	—
—	—	—	—	—	—	—	—	—	—	69132
—	—	—	—	—	—	—	—	—	—	69134
—	—	—	—	—	—	—	—	69135	69135	69135
—	—	—	—	—	—	—	—	89008	89008	89008
—	—	—	—	—	—	—	—	69138	69138	69138
—	—	—	—	—	—	88178	88178	88178	88178	88178
—	—	—	—	—	—	—	—	—	—	—
—	2pk // 85175 6pk // 85180 12pk // 85177 400pk // 85179									
—	—	—	—	—	—	—	—	—	—	—
20237 - 2pk 20238 - 8pk	20237 - 2pk 20238 - 8pk									
—	—	—	—	—	—	—	—	—	—	—
—	—	—	—	—	—	—	—	—	—	—



**THE PROTAC RAIL MOUNT LIGHTS
SHATTER THE DARK
WITHOUT BREAKING THE BANK**

PROTAC® RAIL MOUNT 1 LONG GUN LIGHT

This 350 lumen light features a fixed-mount for MIL-STD 1913 or M-LOK® compatible rails. It uses either a remote switch with momentary/constant on operation or a standard push-button tail switch. Can run on either a lithium battery or an easy-to-find Alkaline battery, both included. IPX7-rated with the Standard button switch installed; waterproof to 1 meter for 30 minutes. IPX4-rated with the remote pressure switch installed.

CR123A	HIGH	LOW
LUMENS:	350	40
CANDELA:	12,000	1,380
DISTANCE:	219m	19m
RUN TIME:	1.75h	14.5h
STROBE RUNS 2.75 HOURS		

ALKALINE	HIGH	LOW
LUMENS:	150	40
CANDELA:	4,950	1,380
DISTANCE:	141m	19m
RUN TIME:	1.5h	8h
STROBE RUNS 2.75 HOURS		



BATTERY: (1) CR123A lithium or (1) "AA" Alkaline
SIZE: 4.25" x 1.5" x 1.2" (10.8 x 3.81 x 3.04 cm)
WEIGHT: 4.3 oz. (121.9g) w/CR123A // 4.5 oz. (127.57g) w/Alkaline
COLOR: Black

[(STROBE)]
 Double tap
 switch to activate

MULTI-FUEL DESIGN:
 Runs on alkaline or
 CR123A lithium battery

TEN-TAP® Programmable -
 choose from three programs:
 • high/strobe
 • high only
 • low/high

ITEM #	DESCRIPTION
88058	ProTac Rail Mount 1 - Includes remote pressure switch, tailcap switch, mounting hardware, M-LOK mount and (1) lithium & (1) "AA" battery

PROTAC® RAIL MOUNT 2 LONG GUN LIGHT

This bright, lightweight, light can be used in close quarter combat or to identify medium range threats. Rugged, reliable and features a fixed-mount for MIL-STD 1913 or M-LOK® compatible rails. It uses either a remote switch with momentary/constant on operation or a standard push-button tail switch. IP67-rated with the Standard button switch installed; waterproof to 1 meter for 30 minutes. IP54-rated with the remote pressure switch installed.

BATTERY: (2) CR123A lithium
SIZE: 5" x 1.5" x 1.2" (12.7 x 3.81 x 3.04 cm)
WEIGHT: 5 oz. (141.7g)
COLOR: Black

CR123A	HIGH	LOW
LUMENS:	625	60
CANDELA:	22,000	2,000
DISTANCE:	297m	89m
RUN TIME:	2h	21h
STROBE RUNS 2.75 HOURS		



ITEM #	DESCRIPTION
88059	ProTac Rail Mount 2 - Includes remote pressure switch, tailcap switch, mounting hardware, M-LOK mount and (2) CR123A lithium batteries

[(STROBE)]
 Double tap switch to activate

TEN-TAP® Programmable - choose from three programs:
 • high/strobe
 • high only
 • low/high

PROTAC® RAIL MOUNT HL-X LONG GUN LIGHT

	HIGH	LOW
LUMENS:	1,000	60
CANDELA:	50,000	3,100
DISTANCE:	447m	111m
RUN TIME [CR123A]:	1.25h	21h
RUN TIME [SL-B26]:	1.75h	24h
STROBE RUNS 2.5 HOURS [CR123A]; 3.5 HOURS [SL-B26]		



[(STROBE)]
 Double tap switch to activate

The ProTac Rail Mount HL-X features a fixed-mount for MIL-STD 1913 or M-LOK® compatible rails. Lightweight, this bright light can be used in close quarter combat or to identify medium range threats. Rugged, reliable and features a remote switch with momentary/constant on operation or a standard push-button tail switch. IP67-rated with the Standard button switch installed; waterproof to 1 meter for 30 minutes. IP54-rated with the remote pressure switch installed.

BATTERY: (2) CR123A lithium or (1) SL-B26 Li-Ion USB rechargeable battery pack
SIZE: 5.43" x 1.45" x 1.72" (13.8 x 3.68 x 4.37 cm)
WEIGHT: 6.4 oz. (181.4g) w/CR123A // 6.9 oz. (195.6g) w/SL-B26
COLOR: Black



MULTI-FUEL DESIGN:
 Runs on CR123A or SL-B26 battery pack

TEN-TAP® Programmable - choose from three programs:
 • high/strobe
 • high only
 • low/high

ITEM #	DESCRIPTION
88066	ProTac Rail Mount HL-X - Includes remote switch, tail switch, remote retaining clips mounting hardware, M-LOK mount and lithium batteries
88071	ProTac Rail Mount HL-X USB - Includes remote switch, tail switch, remote retaining clips mounting hardware, M-LOK mount, SL-B26 battery pack and USB cord

PROTAC® RAIL MOUNT HL-X PRO LONG GUN LIGHT

The ProTac series expands its weapon-mounted lights with this 50,000 candela light with a 447m beam distance. It features a fixed-mount for MIL-STD 1913 or M-LOK® compatible rails. Lightweight, this bright light can be used in close quarter combat or to identify medium range threats. Rugged, reliable and features a remote switch with momentary/constant on operation or a standard push-button switch. Easily replace batteries by unplugging the remote and removing tail cap - no connected wires. IP67-rated without the remote pressure switch installed; waterproof to 1 meter for 30 minutes. IP54-rated with the remote pressure switch installed.

	HIGH	LOW
LUMENS:	1,000	60
CANDELA:	50,000	3,100
DISTANCE:	447m	111m
RUN TIME (CR123A):	1.25h	21h
RUN TIME (SL-B26):	1.75h	24h
STROBE RUNS 2.5 HOURS (CR123A); 3.5 HOURS (SL-B26)		

[[STROBE]]

Double tap
switch to activate

The Jack-Cap® tail cap provides operational switch redundancy, featuring both a push-button switch and a port for a remote pressure switch.



MULTI-FUEL DESIGN:
Runs on CR123A or
SL-B26 batteries



50,000 cd



TEN-TAP® Programmable -
choose from three programs:

- high/strobe
- high only
- low/high

BATTERY: (2) CR123A lithium or (1) SL-B26 Li-Ion USB rechargeable battery pack
SIZE: 5.43" x 1.45" x 1.72" (13.8 x 3.68 x 4.37 cm)
WEIGHT: 6.6 oz. (187.1g) w/CR123A // 7.2 oz. (204.1g) w/SL-B26
COLOR: Black



**1,000
LUMENS**

ITEM #	DESCRIPTION
88126	ProTac Rail Mount HL-X Pro - Includes Jack-Cap®, momentary remote switch, remote retaining clips, mounting hardware, M-LOK mount and lithium batteries
88127	ProTac Rail Mount HL-X Pro USB - Includes Jack-Cap®, momentary remote switch, remote retaining clips, mounting hardware, M-LOK mount, SL-B26 battery pack and USB cord
88128	ProTac Rail Mount HL-X Pro - Light only - Includes Jack-Cap®, M-LOK mount and lithium batteries
88129	ProTac Rail Mount HL-X Pro USB - Light only - Includes Jack-Cap®, M-LOK mount, SL-B26 battery pack and USB cord

PROTAC® RAIL MOUNT HL-X LASER LONG GUN LIGHT

The ProTac Rail Mount HL-X Laser features integrated red aiming laser with windage and elevation adjustments. It has unique functionality with its double switches: push button tailcap or remote pressure switch. Multi-fuel options: the USB rechargeable system includes our SL-B26® protected Li-Ion USB rechargeable battery pack; the lithium battery version includes two CR123A lithium batteries. Each model includes all that you need to mount to your long gun.

	HIGH	LOW
LUMENS:	1,000	60
CANDELA:	18,200	1,100
DISTANCE:	270m	66m
RUN TIME (CR123A):	1.25h	20h
RUN TIME (SL-B26):	1.5h	23h
STROBE RUNS 2.5 HOURS (CR123A); 3.25 HOURS (SL-B26)		

[(STROBE)]
Double tap
switch to activate

**1,000
LUMENS**

MULTI-FUEL DESIGN:
Runs on CR123A or
SL-B26 batteries



TEN-TAP® Programmable -
choose from three programs:
• high/strobe
• high only
• low/high

BATTERY: (2) CR123A lithium or (1) SL-B26 Li-Ion USB rechargeable battery pack
SIZE: 6.56" x 1.47" x 1.76 (16.7 x 3.73 x 4.47 cm)
WEIGHT: 10.8 oz. (306g) w/ SL-B26 // 10.3 oz. (292g) w/CR123A
COLOR: Black

ITEM #	DESCRIPTION
88089	ProTac Rail Mount HL X Laser - Includes remote switch, tail switch, remote retaining clips, mounting hardware and (2) CR123A lithium batteries
88090	ProTac Rail Mount HL-X Laser USB - Includes remote switch, tail switch, remote retaining clips, mounting hardware, SL-B26 battery pack & USB cord



PROTAC® 2.0 RAIL MOUNT

	HIGH	LOW
LUMENS:	2,000	250
CANDELA:	17,700	2,150
DISTANCE:	266m	93m
RUN TIME:	2.5h	11h

STROBE RUNS 4.5 HOURS

[(STROBE)]
Double tap
switch to activate



The high performance ProTac 2.0 Rail Mount produces 2,000 lumens without sacrificing run time. Powered by our proprietary SL-B50® protected Li-Ion rechargeable battery pack that charges using a USB-C cord outside of the light or inside – no need to remove from your weapon.

System includes remote rail grabber, remote pressure momentary switch, push-button tailcap switch and M-LOK® mount and mounting hardware. Tactical tailcap switch provides momentary & “constant on” operation. IP67-rated; dust-tight and waterproof to 1m for 30 minutes.



TEN-TAP® Programmable - choose from three programs:

- high/strobe
- high only
- low/high



Tail cap provides operational switch redundancy, featuring both a push-button switch and a port for a remote pressure switch.



Powered by SL-B50 Li-Ion USB rechargeable battery pack. Recharges in 6 hours.



BATTERY: (1) SL-B50 protected Li-Ion USB rechargeable battery pack
SIZE: 6.3" x 1.46" 1.02" (16 x 3.7 x 2.6 cm)
WEIGHT: 9.06 oz. (257g)
COLOR: Black



Slide sleeve back to access USB-C port; charges via USB-C cord

ITEM #	DESCRIPTION
89009	ProTac 2.0 Rail Mount - System - Includes straight momentary pressure switch, SL-B50 battery pack, mounting hardware, USB-C cord, M-LOK mount
88003	ProTac 2.0 Rail Mount - Light Only - Includes SL-B50 battery pack, USB-C cord and M-LOK mount

PROTAC RAIL MOUNT ACCESSORIES

DESCRIPTION	PART #	GOES WITH
CR123A Lithium Batteries - 2pk CR123A Lithium Batteries - 6pk CR123A Lithium Batteries - 12pk CR123A Lithium Batteries - 400pk	 85175 85177 85179 85180	ProTac Rail Mount 1, ProTac Rail Mount 2, ProTac Rail Mount HL-X, ProTac Rail Mount HL-X Pro, ProTac Rail Mount HL-X Laser
SL-B26 Li-Ion USB Battery Pack Charge Cradle <i>(Includes (2) SL-B26 battery packs and USB cord)</i>	 22010 <i>See pgs 134-135 for more information</i>	ProTac Rail Mount HL-X, ProTac Rail Mount HL-X Pro, ProTac Rail Mount HL-X Laser
8-Unit Li-ion Bank Charger - 12V DC	 20220 <i>See pgs 134-135 for more information</i>	ProTac Rail Mount HL-X, ProTac Rail Mount HL-X Pro, ProTac Rail Mount HL-X Laser
120V AC USB Charge Cord	 22071	ProTac Rail Mount HL-X, ProTac Rail Mount HL-X Pro, ProTac Rail Mount HL-X Laser
SL-B26 Battery Packs - 1pk SL-B26 Battery Packs - 2pk SL-B26 Battery Packs - 8pk	 22101 22102 22105	ProTac Rail Mount HL-X, ProTac Rail Mount HL-X Pro, ProTac Rail Mount HL-X Laser
SL-B50 Battery Packs - 1pk SL-B50 Battery Packs - 2pk	 22111 22112	ProTac 2.0, ProTac 2.0 Rail Mount
40" (101.6 cm) Micro USB Cord 22" (55.88 cm) Micro USB Cord	 22070 22081	ProTac Rail Mount HL-X, ProTac Rail Mount HL-X Pro, ProTac Rail Mount HL-X Laser
22" (55.88 cm) USB-C Cord	 22084	ProTac 2.0, ProTac 2.0 Rail Mount
M-LOK® Mount	 88300	ProTac Rail Mount 1, ProTac Rail Mount 2, ProTac Rail Mount HL-X, ProTac Rail Mount HL-X Pro, ProTac 2.0 Rail Mount
Remote Retaining Clips	 88178	ProTac Rail Mount 1, ProTac Rail Mount 2, ProTac Rail Mount HL-X, ProTac Rail Mount HL-X Pro, ProTac 2.0 Rail Mount
Filters	 69115 (red) 69116 (blue) 69117 (green) 69118 (IR) 69124 (Opaque)	ProTac Rail Mount 1 ProTac Rail Mount 2
Jack-Cap®	 88130	ProTac Rail Mount HL-X Pro
Remote Switch	 880175	ProTac Rail Mount 1, ProTac Rail Mount 2
Remote Switch	 880276	ProTac Rail Mount HL-X Laser
Straight Momentary Pressure Switch	 69135	ProTac Rail Mount HL-X Pro, ProTac 2.0 Rail Mount
Straight Latching Switch	 89008	ProTac Rail Mount HL-X Pro, ProTac 2.0 Rail Mount

TACTICAL SERIES //

TACTICAL LIGHTING SPECIALISTS
FROM EVERYDAY CARRY TO SPECIALIZED HANDS-FREE
LIGHTING. GO TACTICAL WITH STREAMLIGHT

It takes more than a Matte Black or Flat Dark Earth finish to call yourself tactical at Streamlight. We build a complete series of lights dedicated to providing you with the optimal performance for the task at hand. Choose from a full family of ProTac or PolyTac lights with high-lumen, long runtime or multi-fuel options and of course the most versatile military light in the world... the Sidewinder.



WEDGE®



PROTAC® 2.0



POLYTAC® X USB



SIDEWINDER STALK®



PROTAC® 1L-1AA

WEDGE®

The Wedge is a compact, high-performance EDC light designed for clean pocket carry. It's outfitted with an intuitive rotating thumb switch that provides tactile control over the constant-on and THRO® (Temporarily Heightened Regulated Output) modes. Made of rugged anodized aluminum with a waterproof USB-C port, the Wedge balances durability with performance.

	THRO	CONSTANT ON
LUMENS:	1,000	300
CANDELA:	3,000	1,200
DISTANCE:	110m	69m
RUN TIME:	35sec	3h



Battery charge indicator located in the on/off switch as seen in the image to the right.

Charge indication:
Red – Charging // Green – Charged



BATTERY: Lithium Polymer
SIZE: 5.46" x 0.6" x 1" (13.87 x 1.52 x 2.54 cm)
WEIGHT: 3.3 oz. (93.5g)
COLOR: Black, Coyote, Red, Blue or Purple

Outfitted with intuitive rotating thumb switch providing tactile control over constant-on and THRO modes



ITEM #	DESCRIPTION
88810	Wedge - Includes USB-C cord and lanyard - Black
88811	Wedge - Includes USB-C cord and lanyard - Coyote
88814	Wedge - Includes USB-C cord and lanyard - Red
88817	Wedge - Includes USB-C cord and lanyard - Blue
88818	Wedge - Includes USB-C cord and lanyard - Purple
22084	USB-C Cord - 22" (58.8 cm)



Securely attaches to MOLLE, turnout gear, harnesses, etc.



Small enough to fit in your tool bag



Designed for comfortable, deep pocket carry

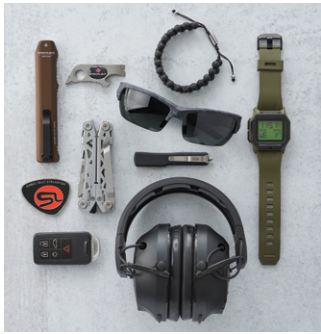

The perfect addition to your EDC kit

WEDGE® XT

The Wedge XT is an ultra-compact, high-performance EDC light engineered with a push-button tail switch for one-handed use.

The Wedge XT features a FIVE-TAP™ Lockout system, which prevents accidental activation inside your pocket or bag. Crafted from rugged anodized aluminum features a built-in waterproof USB-C port for use in virtually any weather condition.

	HIGH	LOW
LUMENS:	500	50
CANDELA:	1,900	200
DISTANCE:	87m	28m
RUN TIME:	2h	11h



Push-button tactical tail switch features constant on or momentary operation and Lockout mode



Another great addition to your EDC kit



TEN-TAP® Programmable - choose from two programs:
• high/low
• low/high



Proven waterproof USB-C port with charge indication LED:
Red – Charging; Green – Charged
Lithium-polymer battery charges in 6 hours



Comfortable, deep pocket carry

BATTERY: Lithium Polymer
SIZE: 4.25" x 0.6" x 1" (10.8 x 1.52 x 2.54 cm)
WEIGHT: 2.62 oz. (74.3g)
COLOR: Black or Coyote

ITEM #	DESCRIPTION
88812	Wedge XT - Includes USB-C cord and lanyard - Black
88813	Wedge XT - Includes USB-C cord and lanyard - Coyote
22084	USB-C Cord - 22" (58.8 cm)



THE PROTAC SERIES...

A COMPLETE FAMILY OF TACTICAL LIGHTS



PROTAC® 1L-1AA

The ProTac 1L-1AA is a perfect everyday carry light. This multi-fuel, ultra-compact flashlight accepts a single lithium or alkaline battery, providing you with ultimate flexibility in the field. Packaged with a removable pocket clip and holster. IPX7-rated; waterproof to 1m for 30 minutes; 2 meter impact-resistance tested.

CR123A	HIGH	LOW	AA	HIGH	LOW
LUMENS:	350	40	LUMENS:	150	40
CANDELA:	6,400	720	CANDELA:	2,750	720
DISTANCE:	160m	53m	DISTANCE:	105m	53m
RUN TIME:	1.5h	14h	RUN TIME (ALK):	1.25h	7.5h
STROBE RUNS 3 HOURS			RUN TIME (LITH):	4.25h	14h
			STROBE RUNS 3.5 HOURS (ALK); 8 HOURS (LITH)		

MULTI-FUEL DESIGN:

Runs on AA alkaline/lithium batteries or CR123A lithium batteries



[(STROBE)]

Double tap switch to activate

TEN-TAP® Programmable -

- choose from three programs:
- high/strobe/low
 - high only
 - low/high

BATTERY: (1) CR123A lithium or (1) "AA" alkaline/lithium
SIZE: 4.25" x 0.95" x 0.85" (10.8 x 2.41 x 2.16 cm)
WEIGHT W/CR123A: 2.5 oz. (71g)
WEIGHT W/AA: 2.8 oz. (79g) w/alkaline // 2.4 oz. (68g) w/lithium
COLOR: Black or Coyote

ITEM #	DESCRIPTION
88061	ProTac 1L-1AA - Includes lithium & AA alkaline battery & holster - Black
88073	ProTac 1L-1AA - Includes lithium & AA alkaline battery & holster - Coyote

PROTAC® 2L

The ProTac 2L is compact and lightweight, yet powerful and bright with long run times and important features. TEN-TAP® programming for user selection of mode programs. IPX7-rated; waterproof to 1m for 30 minutes. 2 meter impact resistance tested. Maximum light output throughout battery life.

	HIGH	LOW
LUMENS:	350	30
CANDELA:	6,300	600
DISTANCE:	159m	49m
RUN TIME:	3.25h	35h
STROBE RUNS 6 HOURS		



[(STROBE)]
Double tap
switch to activate

TEN-TAP® Programmable - choose from three programs:

- high/strobe/low
- high only
- low/high

BATTERY: (2) CR123A lithium
SIZE: 4.77" x 0.9" x 0.77" (12.12 x 2.29 x 1.96 cm)
WEIGHT: 2.8 oz. (79g)
COLOR: Black

ITEM #	DESCRIPTION
88031	ProTac 2L - Includes (2) lithium batteries and holster

PROTAC HL®

This tactical flashlight has a far reaching beam to light up areas with 750 lumens of light. TEN-TAP® programming lets you choose the order of operating modes. IPX7-rated; waterproof to 1m for 30 minutes. 1 meter impact-resistance tested.

	HIGH	LOW
LUMENS:	750	35
CANDELA:	18,300	900
DISTANCE:	270m	60m
RUN TIME:	1.25h	18h
STROBE RUNS 2.5 HOURS		



[(STROBE)]
Double tap
switch to activate

TEN-TAP® Programmable - choose from three programs:

- high/strobe/low
- high only
- low/high

BATTERY: (2) CR123A lithium
SIZE: 5.4" x 1.375" x 1" (13.72 x 3.49 x 2.54 cm)
WEIGHT: 5.6 oz. (158g)
COLOR: Black

ITEM #	DESCRIPTION
88040	ProTac HL - Includes (2) lithium batteries & holster



PROTAC® 2AA-X

The ProTac 2AA-X is a multi-fuel tactical light that can use either a proprietary Streamlight protected lithium polymer USB rechargeable battery pack (included) or two "AA" alkaline batteries. It features a tactical tail cap switch for momentary or constant on operation and three different user selectable programs. Knurled body for a sure grip. Packaged with a removable pocket clip and holster.

LI-PO	HIGH	LOW
LUMENS:	550	40
CANDELA:	10,250	740
DISTANCE:	203m	54m
RUN TIME:	2.25h	16h
STROBE RUNS 4.5 HOURS		

AA	HIGH	LOW
LUMENS:	270	18
CANDELA:	5,000	400
DISTANCE:	141m	40m
RUN TIME:	2.5h	48h
STROBE RUNS 5 HOURS		

[[STROBE]]

Double tap
switch to activate



MULTI-FUEL DESIGN:
Runs on lithium polymer battery pack or alkaline batteries

TEN-TAP® Programmable - choose from three programs:

- high/strobe/low
- high only
- low/high

BATTERY: Lithium polymer USB rechargeable battery pack or (2) "AA" alkaline

SIZE: 6" x 0.9" x 0.7" (15.3 x 2.3 x 1.8 cm)

WEIGHT: 3.5 oz. (99g)

COLOR: Black or Coyote

ITEM #	DESCRIPTION
88135	ProTac 2AA X USB- Includes lithium polymer battery pack, USB-C cord and holster - Black
88137	ProTac 2AA X USB- Includes lithium polymer battery pack, USB-C cord and holster - Coyote
88033	ProTac 2AA - Includes (2) "AA" alkaline batteries and holster - Black
88072	ProTac 2AA - Includes (2) "AA" alkaline batteries and holster - Coyote
88136	Protected lithium polymer USB-C rechargeable battery pack

PROTAC® 2L-X

The ProTac 2L-X is a multi-fuel tactical light that comes in two versions. The ProTac 2L-X USB is a rechargeable system that uses one SL-B26 protected Li-Ion USB rechargeable battery pack. The ProTac 2L-X includes CR123A lithium batteries.

Multi-battery versatility means the user can always use disposable batteries to power the light if the rechargeable is out of power and a charging source is not available. It features a tactical tail cap switch for momentary or constant on operation, three different user selectable programs and a pocket clip for convenience. IPX7-rated; waterproof to 1 meter for 30 minutes; 1 meter impact resistance tested.

MULTI-FUEL DESIGN:
Runs on SL-B26 battery pack or CR123A lithium batteries

	HIGH	LOW
LUMENS:	500	40
CANDELA:	6,800	600
DISTANCE:	165m	49m
RUN TIME (CR123A):	2.75h	30h
RUN TIME (SL-B26):	3.25h	30h
STROBE RUNS 3.25 HOURS (CR123A); 4.5 HOURS (SL-B26)		



[[STROBE]]

Double tap
switch to activate

TEN-TAP® Programmable - choose from three programs:

- high/strobe/low
- high only
- low/high

BATTERY: (1) SL-B26 Li-Ion USB rechargeable battery pack or (2) CR123A lithium

SIZE: 5.14" x 1.06" x 0.94" (13 x 2.7 x 2.4 cm)

WEIGHT: 4.4 oz. (125g) w/SL-B26 // 3.9 oz. (111g) w/CR123A

COLOR: Black

ITEM #	DESCRIPTION
88062	ProTac 2L-X - Includes (2) CR123A lithium batteries & holster - Clam
88063	ProTac 2L-X - Includes (2) CR123A lithium batteries & holster - Box
88082	ProTac 2L-X USB - Includes SL-B26 battery pack, micro USB cord & holster - Clam
88083	ProTac 2L-X USB - Includes SL-B26 battery pack, micro USB cord & holster - Box

PROTAC® HL-X

The ProTac HL-X is a multi-fuel tactical light that comes in two versions. The ProTac HL-X USB is a rechargeable system that uses our Streamlight SL-B26 protected Li-Ion USB rechargeable battery pack with integrated USB charging port. The ProTac HL-X includes CR123A batteries.

Multi-battery versatility means the user can use disposable batteries to power the light if the rechargeable is out of power and a charging source is not available. It features a tactical tail cap switch for momentary or constant on operation, three different user selectable programs and a pocket clip for convenience. IP68-rated; dust tight and waterproof to 2 meters.

	HIGH	MEDIUM	LOW
LUMENS:	1,000	400	65
CANDELA:	27,100	10,000	1,600
DISTANCE:	330m	200m	80m
RUN TIME (CR123A):	1.25h	3h	20h
RUN TIME (SL-B26):	1.5h	3.5h	23h
STROBE RUNS 2.5 HOURS (CR123A); 3.25 HOURS (SL-B26)			



MULTI-FUEL DESIGN:
Runs on SL-B26 battery pack or CR123A lithium batteries

TEN-TAP® Programmable - choose from three programs:
• high/strobe/low
• high only
• low/medium/high

BATTERY: (1) SL-B26 Li-Ion USB rechargeable battery pack or (2) CR123A lithium
SIZE: 5.43" x 1.44" x 1" (13.8 x 3.7 x 2.54 cm)
WEIGHT: 6.2 oz. (176g) w/SL-B26 // 5.7 oz. (162g) w/CR123A
COLOR: Black

ITEM #	DESCRIPTION
95313	ProTac HL-X - Includes (2) CR123A lithium batteries & holster - Box
88064	ProTac HL-X - Includes (2) CR123A lithium batteries & holster - Clam
88065	ProTac HL-X - Includes (2) CR123A lithium batteries & holster - Box
95314	ProTac HL-X USB - Includes SL-B26 battery pack, USB cord & holster - Box
88084	ProTac HL-X USB - Includes SL-B26 battery pack, USB cord & holster - Clam
88085	ProTac HL-X USB - Includes SL-B26 battery pack, USB cord & holster - Box

PROTAC® 90X

The multi-fuel ProTac 90X is an EDC light with a twist. It features a right-angle head that gives extra lighting capability for those with multiple lighting needs. Carry in your hand or attach to your MOLLE, belts, harnesses and other gear for hands-free use. IPX7-rated; waterproof to 1m for 30 minutes; 2m impact-resistance tested.

	HIGH	MEDIUM	LOW
LUMENS:	1,000	300	65
CANDELA:	7,350	2,060	450
DISTANCE:	171m	91m	42m
RUN TIME (CR123A):	2.5h	4h	21h
RUN TIME (SL-B26):	1.75h	4.75h	24h
STROBE RUNS 2.5 HOURS (CR123A); 3.5 HOURS (SL-B26)			



[(STROBE)]
Double tap
switch to activate

TEN-TAP® Programmable - choose from three programs:
• high/strobe/low
• high only
• low/medium/high



BATTERY: (1) SL-B26 Li-Ion USB rechargeable battery pack or (2) CR123A lithium
SIZE: 4.39" x 1.14" x 0.94" (11.1 x 2.9 x 2.4 cm)
WEIGHT: 4.9 oz. (139g) w/SL-B26 // 4.4 oz. (125g) w/CR123A
COLOR: Black

ITEM #	DESCRIPTION
88094	ProTac 90X - Includes 2() CR123A lithium batteries and holster
88095	ProTac 90X USB - Includes SL-B26 battery pack, USB cord and holster



PROTAC HL® 6



The ProTac HL-6 is a high-powered, multi-fuel tactical light that produces 5,300 lumens for two hours. Multi-battery versatility means the user can always use disposable batteries to power the light if the rechargeable is out of power and a charging source is not available. Features a “sure grip rubber sleeve” and includes a lanyard.

	HIGH	MEDIUM	LOW
LUMENS:	5,300	1,500	450
CANDELA:	80,000	23,000	6,700
DISTANCE:	566m	303m	164m
RUN TIME:	2h	3.75h	12.5h
STROBE RUNS 4 HOURS			

[(STROBE)]

Double tap switch to activate

BATTERY: (2) SL-B48 Li-Ion USB rechargeable battery packs
SIZE: 10.5" x 2.35" x 1.25" (26.6 x 6 x 3.2 cm)
WEIGHT: 1.3 lbs. (590g)
COLOR: Black



HL®



TEN-TAP® Programmable - choose from three programs:
 • high/strobe/low
 • high only
 • low/medium/high

ITEM #	DESCRIPTION
88131	ProTac HL 6 - 120V AC Adapter - Includes (2) SL-B48 rechargeable batteries, "Y" USB-C cord and wrist lanyard
88132	ProTac HL 6 - Includes (2) SL-B48 rechargeable batteries "Y" USB-C cord and wrist lanyard

PROTAC HL® 5-X

The ProTac HL 5-X is a high-powered, multi-fuel tactical light available in two configurations. The ProTac HL 5-X USB is a rechargeable system that uses two SL-B26 protected Li-Ion USB rechargeable battery packs. The ProTac HL 5-X includes four CR123A batteries. Multi-battery versatility means the user can always use disposable batteries to power the light if the rechargeable is out of power and a charging source is not available. Features a “sure grip rubber sleeve” and includes a lanyard.



HL®



[(STROBE)]

Double tap switch to activate

BATTERY: (2) SL-B26 Li-Ion USB rechargeable battery packs or (4) CR123A lithium
SIZE: 9.53" x 2.35" x 1.24" (23.65 x 5.97 x 3.15 cm)
WEIGHT: 1 lb. 3.4 oz. (550g) w/SL-B26 // 1 lb. 2.4 oz. (522g) w/CR123A
COLOR: Black

MULTI-FUEL DESIGN:
 Runs on SL-B26 battery pack or CR123A lithium batteries

TEN-TAP® Programmable - choose from three programs:
 • high/strobe/low
 • high only
 • low/medium/high

SL-B26	HIGH	MEDIUM	LOW
LUMENS:	3,500	1,000	250
CANDELA:	51,000	14,100	3,620
DISTANCE:	452m	237m	120m
RUN TIME:	1.25h	3h	11.5h
STROBE RUNS 1.25 HOURS			
CR123A	HIGH	MEDIUM	LOW
LUMENS:	2,500	1,000	250
CANDELA:	37,000	14,100	3,620
DISTANCE:	385m	237m	120m
RUN TIME:	1.5h	2.5h	10.5h
STROBE RUNS 1.5 HOURS			

ITEM #	DESCRIPTION
88074	ProTac HL 5-X - Includes (4) lithium batteries & wrist lanyard - Clam
88075	ProTac HL 5-X - Includes (4) lithium batteries & wrist lanyard - Box
88080	ProTac HL 5-X USB - Includes (2) SL-B26 battery packs, "Y" micro USB cord and lanyard - Clam
88081	ProTac HL 5-X USB - Includes (2) SL-B26 battery packs, "Y" micro USB cord and lanyard - Box

PROTAC® HPL USB

A versatile USB rechargeable tactical light designed for down range applications. Multi-battery versatility means you can use disposable batteries to power the light when a charging source is not available. It features a tail cap switch for momentary or constant on operation, three different user selectable programs and a pocket clip for convenience. IPX4-rated; water-resistant .

	HIGH	MEDIUM	LOW
LUMENS:	1,000	400	65
CANDELA:	35,000	14,100	2,250
DISTANCE:	374m	237m	95m
RUN TIME:	1.5h	3.5h	24h
STROBE RUNS 3 HOURS			



TEN-TAP® Programmable - choose from three programs:

- high/strobe/low
- high only
- low/medium/high

BATTERY: Lithium-ion (included), SL-B26 battery pack or (2) CR123A lithium
SIZE: 7.08" x 1.72" x 1.07" (18 x 4.38 x 2.7 cm)
WEIGHT: 9.24 oz. (262g)
COLOR: Black

ITEM #	DESCRIPTION
88076	ProTac HPL USB - Includes micro USB cord and holster - Clam
88077	ProTac HPL USB - Includes micro USB cord and holster - Box

PROTAC HL® USB

The ProTac HL USB features multiple power source capability; it includes a rechargeable lithium-ion battery; also accepts Streamlight SL-B26 rechargeable lithium-ion battery or two CR123A batteries. An anti-rattle battery compartment keeps batteries securely and quietly in place without using a separate battery carrier. TEN-TAP programming lets you choose the selection of operating modes. IPX4-rated; water-resistant.

	HIGH	MEDIUM	LOW
LUMENS:	1,000	380	65
CANDELA:	12,000	4,420	700
DISTANCE:	219m	133m	53m
RUN TIME:	1.5h	3.5h	23h
STROBE RUNS 1.5 HOURS			



TEN-TAP® Programmable - choose from three programs:

- high/strobe/low
- high only
- low/medium/high

BATTERY: Lithium-ion (included), SL-B26 battery pack or (2) CR123A lithium
SIZE: 6.50" x 1.23" x 1.07" (16.5 x 3.1 x 2.7 cm)
WEIGHT: 7.2 oz. (204g)
COLOR: Black

ITEM #	DESCRIPTION
88052	ProTac HL USB - Includes micro USB cord and holster - Clam
88054	ProTac HL USB - 120V AC/12V DC and holster - Clam

PROTAC // POLYTAC ACCESSORIES

ITEM	PART #	GOES WITH
CR123A Lithium Batteries - 2pk CR123A Lithium Batteries - 6pk CR123A Lithium Batteries - 12pk CR123A Lithium Batteries - 400pk	85175 85180 85177 85179	ProTac 1L-1AA, ProTac 2L, ProTac 2L-X, ProTac HL, ProTac HL-X, ProTac HL USB, ProTac HPL USB, ProTac HL 5-X, PolyTac X
SL-B26 Battery Pack	See page 134 for more information	ProTac HL USB, ProTac HPL USB, ProTac HL-X, ProTac 2L-X, ProTac HL 5-X, PolyTac X
40" (101.6 cm) Micro USB Cord 22" (55.88 cm) Micro USB Cord	22070 22081	ProTac HL USB, ProTac HPL USB, ProTac HL-X USB, ProTac 2L-X USB, ProTac HL 5-X USB, PolyTac X USB
SL-B50 Battery Pack - 1pk SL-B50 Battery Pack - 2pk	22111 22112	ProTac 2.0
Lithium Polymer Battery Pack	88136	ProTac 2AA-X USB
22" (55.88 cm) USB-C Cord	22084	ProTac 2AA-X USB, ProTac 2.0, Wedge, Wedge XT
"Y" Micro USB Cord	22082	ProTac HL 5-X USB
Nylon Holster	88037 88036	ProTac 1L-1AA ProTac 2L
Nylon Holster	88038 88043 88086	ProTac 2AA, ProTac 2AA-X USB ProTac HL ProTac 2.0
Nylon Holster	85905	PolyTac X
Nylon Holster	85909	PolyTac X
Tactical Holster	88051	ProTac HL, ProTac HL USB
Flip Lens - Red Flip Lens - Blue Flip Lens - Green Flip Lens - IR	85115 85116 85117 74039	PolyTac X
Safety Wand	88057	ProTac HL, ProTac HL-X, ProTac 2.0
Helmet Mount	68085	PolyTac
Rubber Helmet Strap	99075	PolyTac X

STREAMLIGHT
PROTAC SERIES



**STREAMLIGHT
POLYTAC SERIES**



POLYTAC® X

This multi-fuel tactical light allows the user to use disposable batteries to power the light if the rechargeable battery pack is out of power and can't be charged. Superior grip texture for a comfortable/slip-resistant feel. TEN-TAP® programming lets you choose the order of operating modes. IPX7-rated; waterproof to 1m for 60 minutes. Maximum light output throughout battery life.

BATTERY: (1) SL-B26 Li-Ion USB rechargeable battery pack or (2) CR123A lithium

SIZE: 5.46" x 1.25" x 1" (13.87 x 3.18 x 2.54 cm)

WEIGHT: 4.9 oz. (139g) w/SL-B26 // 4.4 oz. (125g) w/CR123A

COLOR: Black, Yellow or Coyote

	HIGH	MEDIUM	LOW
LUMENS:	600	260	35
CANDELA:	11,485	4,930	675
DISTANCE:	205m	135m	50m
RUN TIME (CR123A):	2.75h	5.5h	34h
RUN TIME (SL-B26):	3.5h	5.75h	36h
STROBE RUNS 5.5 HOURS (CR123A); 8 HOURS (SL-B26)			

CLAM	BOX	DESCRIPTION
88600	88603	PolyTac X - Includes (2) CR123A lithium batteries - Black
88601	88604	PolyTac X - Includes (2) CR123A lithium batteries - Yellow
88602	88605	PolyTac X - Includes (2) CR123A lithium batteries - Coyote
88610	88613	PolyTac X USB - Includes SL-B26 battery pack & USB cord - Black
88611	88614	PolyTac X USB - Includes SL-B26 battery pack & USB cord - Yellow
88612	88615	PolyTac X USB - Includes SL-B26 battery pack & USB cord - Coyote

MULTI-FUEL DESIGN:
Runs on SL-B26 battery pack or CR123A lithium batteries

NFPA
Meets requirements of 1971-8.6 (2018); 500° heat resistance test

TEN-TAP® Programmable - choose from three programs:
• high/strobe/low
• high only
• low/medium/high



POLYTAC®

Rugged housing, superior brightness and extended run times make the PolyTac ideal for the broadest range of lighting applications at the best value. Superior grip texture for a comfortable/slip-resistant feel. TEN-TAP® programming lets you choose the order of operating modes. IPX7-rated; waterproof to 1m for 30 minutes. Maximum light output throughout battery life.

BATTERY: (2) CR123A lithium

SIZE: 5.34" x 1.25" x 1" (13.56 x 3.18 x 2.54 cm)

WEIGHT: 4.2 oz. (121g)

COLOR: Black, Coyote or Yellow

ITEM #	DESCRIPTION
88850	PolyTac - Includes lithium batteries - Black
88851	PolyTac - Includes lithium batteries - Coyote
88853	PolyTac - Includes lithium batteries - Yellow

	HIGH	MEDIUM	LOW
LUMENS:	600	260	35
CANDELA:	11,500	4,900	675
DISTANCE:	214m	140m	52m
RUN TIME:	2.75h	5.5h	34h
STROBE RUNS 5.5 HOURS			

NFPA

Meets requirements of NFPA 1971-8.6 (2018)



[(STROBE)]

Double tap switch to activate

TEN-TAP® Programmable - choose from three programs:

- high/strobe/low
- high only
- low/medium/high

POLYTAC 90® X

Rugged and super bright, the PolyTac 90 X is built with the rigors of the job in mind. Features a switch with built in battery life indicator that will let you know when it is time to recharge your battery or replace them. The PolyTac 90 X USB is a rechargeable system that includes a Streamlight SL-B26 protected Li-Ion USB rechargeable battery pack. The PolyTac 90 X includes two CR123A batteries.

BATTERY: (1) SL-B26 battery pack or (2) CR123A lithium

SIZE: 4.43" x 1.3" x 1.11" (11.25 x 3.3 x 2.82 cm)

WEIGHT: 4.8 oz. (136g) w/SL-B26 // 4.3 oz. (122g) w/CR123A

COLOR: Orange, Yellow or Black

ORANGE	YELLOW	BLACK	DESCRIPTION
88834	88831	88830	PolyTac 90 X - Includes (2) CR123A lithium batteries
88832	--	--	PolyTac 90 X - Includes (2) CR123A lithium batteries and Gear Keeper
88838	88836	88835	PolyTac 90 X USB - Includes SL-B26 Battery Pack & micro USB cord
88837	--	--	PolyTac 90 X USB - Includes SL-B26 Battery Pack & micro USB cord

	HIGH	LOW
LUMENS:	500	85
CANDELA:	7,000	1,050
DISTANCE:	167m	64m
RUN TIME(CR123A):	2.5h	12h
RUN TIME (SL-B26):	3.75h	19h



MULTI-FUEL DESIGN:
Runs on SL-B26 battery pack or CR123A lithium batteries

NFPA

Meets requirements of 1971-8.6 (2018)

SL-B26[®] BATTERY PACK

THE BATTERY THAT REINVENTS RECHARGEABILITY



TURN YOUR HIGH-PERFORMANCE LIGHTS INTO RECHARGEABLE SYSTEMS

You know how you make the best performing, brightest lights in the business even better? Simple. Give users multiple ways to power and charge them. Introducing our SL-B26[®] Protected Lithium-ion USB Rechargeable Battery Pack with integrated charging port. Charges by USB cord, or optional charge cradle. Flexibility for however and wherever you use your light.

SL-B26[®] PROTECTED LITHIUM-ION USB RECHARGEABLE BATTERY PACK

The battery that transforms multi-fuel, high-performance lighting tools into rechargeable systems. USB rechargeable - Features micro-USB input and charge status indicators; charges in 5 hours. Integrated safety circuit protects battery from overcharge. Charge via USB source or optional charge cradle - or bank charger for departmental use. The charge cradle is ideal for storage as well as to charge your batteries.



Features integrated USB port.
Charge status LEDs:

Red = charging Green = charged

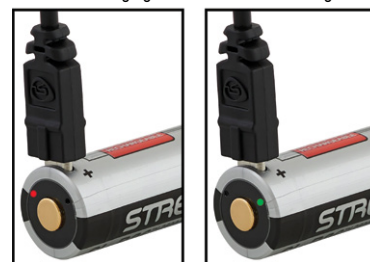

CHARGING **CHARGED**

USB Rechargeable 2600mAh SL-B26 Lithium-ion Battery — Charges in 5 hours.

BATTERY CAPACITY: 2600mAh SL-B26 protected Li-Ion USB rechargeable battery pack

BATTERY SIZE: 2.75" x 0.744" (7 x 1.89 cm)

BATTERY WEIGHT: 1.7 oz. (48g)

CRADLE SIZE: 4.5" (11.4cm)

CRADLE WEIGHT: 2.4 oz. (68g)

ITEM #	DESCRIPTION
22101	SL-B26 Li-Ion USB rechargeable battery pack - 1pk
22102	SL-B26 Li-Ion USB rechargeable battery pack - 2pk
22104	SL-B26 Li-Ion USB rechargeable battery pack - 2pk - Box
22105	SL-B26 Li-Ion USB rechargeable battery pack - 8pk
22100	Li-Ion Charge Cradle
22010	Li-ion Rechargeable Battery Kit - Includes USB-C cord and (2) SL-B26 battery pack
22011	Li-ion Rechargeable Battery Kit - 120V AC - Includes (2) SL-B26 battery packs
22070	40" (101 cm) micro USB Cord
22081	22" (55.88 cm) micro USB Cord



Charger temperature safety circuit prevents damage to batteries while charging.

MULTI-FUEL LIGHTING SYSTEMS



Siege® X USB

Vantage®
180 X USB

ProTac®
HL-X USB

ProTac®
90X USB

PolyTac
90° X USB

PolyTac® X USB

ProTac®
2L-X USB

ProTac
HL® 5-X USB



Survivor® X USB

Survivor Pivot® USB

ALSO WORKS WITH:

SL-B26 battery pack sold separately. available as system that includes lithium-ion battery #74175 (also used in Strion series).



ProTac® HL USB Headlamp



ProTac HL® USB



ProTac® HPL USB

ORGANIZE, STORE AND CHARGE YOUR SL-B26 BATTERIES

EIGHT-UNIT SL-B26 BANK CHARGER

Charge up to eight batteries with Streamlight's lithium-ion battery bank charger. Each charge bay securely holds the battery in place - ideal for mounting on trucks. Low-profile housing (1"; 2.54 cm) requires minimal mounting area.

Charge time = 5.25 hours

Charge indicators over each battery:

- Red = charging
- Green = charged

Charges with or without optional charge cradle. Use the charge cradle for storage as well as to charge your batteries.

BATTERY CAPACITY: 8

SIZE: 10.45" x 4.75" x 1" (26.54 x 12.06 x 2.54 cm)

WEIGHT WITHOUT BATTERIES: 7.61 oz. (216g)

WEIGHT WITH BATTERIES: 20.88 oz. (592g)



NFPA

Meets requirements of NFPA 1900-11.1.11.2 (2024); mounted in upright position

ITEM #	DESCRIPTION
20221	8-Unit Li-Ion Bank Charger - 120V AC
20220	8-Unit Li-Ion Bank Charger - 12V DC
20224	8-Unit Bank Charger - with SL-B26 battery packs - 120V AC
20223	8-Unit Bank Charger - with SL-B26 battery packs - 12V DC
44909	120V AC Cord
44923	12V DC Cord



120V AC Charge Cord



12V DC Charge Cord

PROTAC® 2.0

	HIGH	MEDIUM	LOW
LUMENS:	2,000	570	100
CANDELA:	17,300	5,000	890
DISTANCE:	262m	142m	60m
RUN TIME:	2.5h	4.5h	25h

STROBE RUNS 4 HOURS 25 MINUTES

The high performance ProTac 2.0 produces 2,000 lumens without sacrificing run time. Powered by our SL-B50® protected Li-Ion rechargeable battery pack that charges outside or inside the light using a USB-C cord. IP67-rated; dust-tight and waterproof to 1 meter for 30 minutes.

BATTERY: (1) SL-B50 protected Li-Ion USB rechargeable battery pack
SIZE: 6.1" x 1.46" x 1.02" (15.5 x 3.7 x 2.6 cm)
WEIGHT: 8.25 oz. (234g)
COLOR: Black

ITEM #	DESCRIPTION
89000	ProTac 2.0 - Includes SL-B50 battery pack, USB-C cord and nylon holster

TEN-TAP® Programmable - choose from three programs:

- high/strobe/low
- high only
- low/medium/high

[(STROBE)]

Double tap switch to activate

**2,000
LUMENS**



Slide sleeve back to access USB-C port.

SL-B50 battery pack charges in 6 hours.



SL-B50® PROTECTED LITHIUM-ION USB RECHARGEABLE BATTERY PACK

The Streamlight proprietary SL-B50 protected Li-Ion rechargeable battery pack, with on-board safety control circuit, is designed for select Streamlight products. It features a built in USB-C port and charge status indicator; charges in 6 hours.

BATTERY CAPACITY: 4900mAh SL-B50 protected Li-Ion USB rechargeable battery pack
BATTERY SIZE: 3.26" x 0.905" (8.28 x 2.3 cm)
BATTERY WEIGHT: 3 oz. (85g)



USB-C Cord



Features integrated USB port.
Charge status LEDs:



CHARGING

CHARGED

USB Rechargeable 4900mAh SL-B50
Lithium-ion Battery — Charges in 6 hours

ITEM #	DESCRIPTION
22111	SL-B50 Li-Ion USB rechargeable battery pack - 1pk
22112	SL-B50 Li-Ion USB rechargeable battery pack - 2pk
22084	22" (55.88 cm) USB-C Cord

WORKS WITH:



ProTac® 2.0
Headlamp



ProTac® 2.0



ProTac® 2.0
Rail Mount

SIDEWINDER... THE MOST VERSATILE MILITARY LIGHTS IN THE WORLD



SIDEWINDER STALK®

Designed to minimize the number of illuminators and beacons an operator must carry, the low-profile Sidewinder Stalk provides ultimate maneuverability. Put light where you need it with multiple mounting options and a flexible stalk to aim the beam.

Features white, multi-colored and IR LEDs along with an IR/IFF beacon.

BATTERIES: (1) CR123A, (1) "AA" alkaline or (1) "AA" lithium
SIZE: 5.51" x 0.86" x 1.81" (14 x 2.18 x 4.60 cm)
WEIGHT: 3.20 oz. (90.72g) with CR123A battery and Hook and loop adapter // 2.88 oz. (81.65g) with AA battery and Hook and loop adapter
COLOR: Coyote or Black



White, red, green, blue and IR LEDs

Thumb Screw to lock into ARC rail slot

Uses "AA" alkaline battery or CR123A lithium (both included)

Also accepts "AA" lithium batteries for extended operation in extreme temperatures

Sidewinder Stalk does not need to be removed from mounted position in order to change batteries

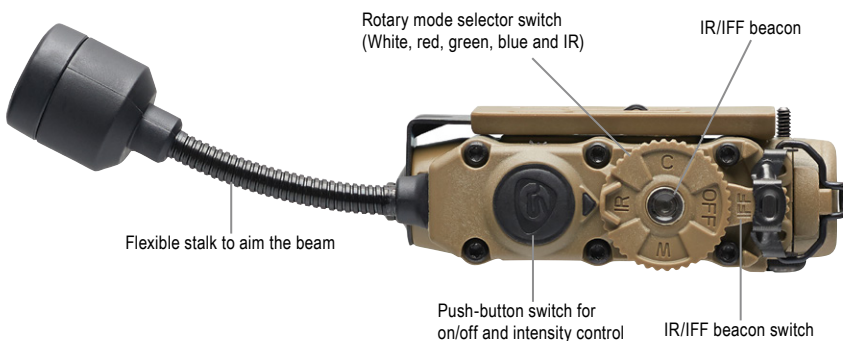

Rotary mode selector switch (White, red, green, blue and IR)

IR/IFF beacon

Flexible stalk to aim the beam

Push-button switch for on/off and intensity control

IR/IFF beacon switch

ITEM #	DESCRIPTION
14300	Sidewinder Stalk - Includes helmet clip, CR123A & "AA" alkaline batteries – Coyote – Mailer
14310	Sidewinder Stalk - Includes helmet clip, CR123A & "AA" alkaline batteries – Black – Mailer
14301	Sidewinder Stalk - Includes helmet clip, Arc rail mount & assembly, CR123A & "AA" alkaline battery – Coyote – Mailer
14311	Sidewinder Stalk - Includes helmet clip, Arc rail mount & assembly, CR123A & "AA" alkaline battery – Black – Mailer
14302	Sidewinder Stalk - Includes helmet clip, E-Mount, CR123A & "AA" alkaline batteries – Coyote – Mailer
14306	Sidewinder Stalk - Includes helmet clip, CR123A & "AA" alkaline batteries – Coyote – Retail Box
14307	Sidewinder Stalk - Includes arc rail mount & assembly, CR123A & "AA" alkaline batteries – Coyote – Retail Box
14308	Sidewinder Stalk - Includes helmet clip, E-Mount, CR123A & "AA" alkaline batteries – Coyote – Retail Box

HIGH (100%) OUTPUT - CR123A						
	WHITE LED	IR LED	RED LED	BLUE LED	GREEN LED	3535 IFF IR LED
LUMENS:	76	5.0 lmW/sr (min) radiant intensity	9	8	20	5.0 lmW/sr (min) radiant intensity
DISTANCE:	28m	---	7m	8m	12m	---
RUN TIME:	5.6h	32h	19h	13h	13h	21h

HIGH (100%) OUTPUT - AA LITHIUM/ALKALINE						
	WHITE LED	IR LED	RED LED	BLUE LED	GREEN LED	3535 IFF IR LED
LUMENS:	57	5.0 lmW/sr (min) radiant intensity	9	8	20	5.0 lmW/sr (min) radiant intensity
DISTANCE:	23m	---	7m	8m	12m	---
RUN TIME:	6h [lith] 3.8h [alk]	33h [lith] 20h [alk]	19h [lith] 10h [alk]	13h [lith] 6h [alk]	13h [lith] 5h [alk]	32h [lith] 19h [alk]



SIDEWINDER STALK BATTERY RUN TIME				
CR123A LITHIUM BATTERY				
LED	LOW	MEDIUM	HIGH	STROBE
WHITE	95 hrs	15 hrs	5.6 hrs	11 hrs
RED	112 hrs	36 hrs	19 hrs	34 hrs
GREEN	80 hrs	27 hrs	13 hrs	25 hrs
BLUE	80 hrs	27 hrs	13 hrs	25 hrs
IR	174 hrs	57 hrs	32 hrs	61 hrs
IR W/ IFF BEACON	150 hrs	40 hrs	21 hrs	43 hrs
"AA" LITHIUM / ALKALINE BATTERY				
WHITE	79 hrs [lith] 66 hrs [alk]	16 hrs [lith] 8 hrs [alk]	6 hrs [lith] 3.8 hrs [alk]	11 hrs [lith] 5.5 hrs [alk]
RED	109 hrs [lith] 85 hrs [alk]	36 hrs [lith] 24 hrs [alk]	19 hrs [lith] 10 hrs [alk]	36 hrs [lith] 25 hrs [alk]
GREEN	84 hrs [lith] 55 hrs [alk]	26 hrs [lith] 15 hrs [alk]	13 hrs [lith] 5 hrs [alk]	23 hrs [lith] 17 hrs [alk]
BLUE	77 hrs [lith] 61 hrs [alk]	25 hrs [lith] 16 hrs [alk]	13 hrs [lith] 6 hrs [alk]	25 hrs [lith] 18 hrs [alk]
IR	173 hrs [lith] 145 hrs [alk]	55 hrs [lith] 39 hrs [alk]	33 hrs [lith] 20 hrs [alk]	60 hrs [lith] 41 hrs [alk]
IR W/ IFF BEACON	187 hrs [lith] 115 hrs [alk]	51 hrs [lith] 38 hrs [alk]	32 hrs [lith] 19 hrs [alk]	47 hrs [lith] 35 hrs [alk]

**STREAMLIGHT
SIDEWINDER SERIES**



The Sidewinder Stalk can be configured to mount on any type of combat, vehicle crew or aviation helmet system and/or MOLLE vest platform, or be directly attached to the brim of a patrol cap.

#14303 - Sidewinder Stalk Helmet Clip
Durable belt/clothing clip with integral helmet mount features



#14304 - Sidewinder Stalk Arc Rail Clip
ARC Rail™ Clip



#14305 - Sidewinder Stalk Arc Rail Mount
Hook and loop adapter plate



Securely attaches to MOLLE



STREAMLIGHT SIDEWINDER SERIES

SIDEWINDER®

Meets a wide variety of hands-free illumination requirements with various color LEDs at different outputs. 185° tilting head and belt/web clip for multiple positioning/aiming of light. Designed for easy selection of light modes when in the field and when wearing gloves. IPX7-rated; waterproof to 1 meter for 30 minutes. 3 meter impact-resistance tested. O-ring and gasket-sealed for waterproof operation. Meets MIL-STD-810F, METHOD 512.4.

BATTERY: (2) "AA" alkaline or "AA" lithium for extended operation in extreme temperatures (-40°F to +150°F)

SIZE: 2.34" x 1.08" x 4.65" (4.94 x 2.74 x 11.81 cm)

WEIGHT: 4.38 oz. (124g) w/lithium // 5.02 oz. (142g) w/Alkaline

COLOR: Coyote



	HIGH
LUMENS:	55
CANDELA:	1,175
DISTANCE:	69m
RUN TIME:	5.5h



ITEM #	DESCRIPTION
MILITARY MODEL [WHITE, RED, BLUE, IR LEDS]	
14000	Sidewinder Military - Includes (2) "AA" alkaline batteries - Clam
14032	Sidewinder Military - Includes (2) "AA" alkaline batteries - Box
14027	Sidewinder Military - Includes helmet mount & (2) "AA" alkaline batteries - Clam
14031	Sidewinder Military - Includes E-mount & (2) "AA" alkaline batteries - Clam
14072	Sidewinder Military - Includes paracord & (2) "AA" alkaline batteries - Clam
AVIATION MODEL [WHITE, GREEN, BLUE, IR LEDS]	
14008	Sidewinder Aviation - Includes (2) "AA" alkaline batteries - Clam
14024	Sidewinder Aviation - Includes MOLLE retainer & (2) "AA" alkaline batteries - Box

SIDEWINDER LIGHT OUTPUT & BATTERY RUN TIME						
LED	Light Output	Low 5% Output	Medium 1 25% Output	Medium 2 60% Output	High 100% Output	Strobe 100% Output
White	55 Lumens	100 hrs+	45 hrs	11 hrs	5.5 hrs	10 hrs
IR	25mW/sr [min] radiant intensity	200 hrs+	140 hrs	60 hrs	24 hrs	40 hrs
Red	1 Lumen	200 hrs+	140 hrs	60 hrs	24 hrs	40 hrs
Blue	1.8 Lumens	150 hrs+	100 hrs	35 hrs	16 hrs	30 hrs
Green	4.5 Lumens	150 hrs+	100 hrs	35 hrs	16 hrs	30 hrs

All run time to 10% of initial output level. Illumination output electronically regulated.

SIDEWINDER® RESCUE PM AIR WARRIOR APPROVED

A lightweight hands-free lighting tool with four different color LEDs, each with varying intensities for a wide variety of tasks. It features a flashing beacon that coupled with the "Slide-in-Place" diffuser, projects omni-directional light to signal for help. The integrated diffuser allows you to go from tight, focused beam to wide, soft beam. Accepts either two "AA" alkaline batteries or two "AA" lithium batteries for maximum versatility in the field. IPX7-rated; waterproof to 1 meter for 30 minutes.

BATTERY: (2) "AA" alkaline or "AA" lithium for extended operation in extreme temperatures (-40°F to +150°F)

SIZE: 2.34" x 1.08" x 4.65" (4.94 x 2.74 x 11.81 cm)

WEIGHT: 4.38 oz. (124g) w/lithium // 5.02 oz. (142g) w/alkaline

COLOR: Coyote

ITEM #	DESCRIPTION
RESCUE MODEL [WHITE, GREEN, BLUE, IR LEDS WITH DIFFUSER]	
14065	Sidewinder Rescue Kit - Includes MOLLE retainer, paracord & (2) "AA" alkaline batteries - Box
14069	Sidewinder Rescue Kit - Includes MOLLE retainer, paracord & (2) "AA" alkaline batteries - Clam
14066	Sidewinder Rescue - Includes (2) "AA" alkaline batteries - Box
14067	Sidewinder Rescue - Includes (2) "AA" alkaline batteries - Clam
14068	Sidewinder Rescue - Includes E-mount & (2) "AA" alkaline batteries - Box



"Slide-in-Place" diffuser can be used with any LED color for omni-directional light

Aluminum plate provides flat surface to adhere Velcro® for attaching to helmet

Cord attachment for paracord lanyard, which provides extra security from loss of light and allows it to be worn around the neck

Securely attaches to MOLLE or other straps using MOLLE retainer



SIDEWINDER COMPACT® II

Extremely versatile lighting tool with white light and a variety of color LEDs for multiple tasks. Fits in the palm of your hand, or clips to MOLLE vest, belt, hat brim or pocket. Helmet mount also available. Rotates 185° for easy aiming of light. Unbreakable, scratch-resistant lens. Special design for easy operation even when wearing heavy gloves. IPX7-rated; waterproof to 1 meter for 30 minutes. 3 meter impact-resistance tested. O-ring and gasket-sealed for waterproof operation. Meets MIL-STD-810F, METHOD 512.4.

BATTERY: (1) "CR123A" lithium, (1) "AA" alkaline, or (1) "AA" lithium
SIZE: 3" x 1.07" x 2.04" (7.62 x 2.72 x 5.21 cm)
WEIGHT: 2.4 oz. (68g) // 3.3 oz. (94g) w/Helmet Mount
COLOR: Coyote

	HIGH CR123A	HIGH "AA" LITHIUM	HIGH "AA" ALKALINE
LUMENS:	55	47	47
CANDELA:	1,175	1,000	1,000
DISTANCE:	69m	63m	63m
RUN TIME:	6h	6h	2h



Military Model



Aviation Model



Rescue Model

ITEM #	DESCRIPTION
MILITARY MODEL [WHITE, RED, BLUE, IR LEADS]	
14512	Sidewinder Compact II Military - Includes helmet mount, headstrap and (1) CR123A lithium battery - Clam
14513	Sidewinder Compact II Military - Includes E-mount, headstrap and (1) CR123A lithium battery - Box
14515	Sidewinder Compact II Military - Includes NVG mount (works w/ DoD, NATO & ISAF combat helmets) and (1) CR123A battery - Box
AVIATION MODEL [WHITE, GREEN, BLUE, IR LEADS]	
14531	Sidewinder Compact II Aviation - Includes rail mount, headstrap and (1) CR123A lithium battery - Clam
14533	Sidewinder Compact II Aviation - NVG mount (works with HGU-84 rotary wing aircrew helmet) and (1) "AA" alkaline battery - Box
RESCUE MODEL [WHITE, GREEN, BLUE, IR LEADS WITH DIFFUSER]	
14534	Sidewinder Compact II Rescue - Includes (1) "AA" alkaline & CR123A battery - Box

STREAMLIGHT SIDEWINDER SERIES

SIDEWINDER BOOT®

	HIGH	LOW
LUMENS:	55	7
CANDELA:	1,000	140
DISTANCE:	63m	24m
RUN TIME:	8h	90h

The Sidewinder Boot is the new standard light for boot camp, recruit/basic training and wherever extra military instruction occurs. It's a durable hands-free task light that features a high-impact, super-tough, polymer case that offers exceptional durability and weather resistance. It's IPX7-rated; 1m drop tested and includes an integrated red filter that slides into place when needed.

BATTERY: (2) "AA" Alkaline; also accepts "AA" lithium
SIZE: 1.86" x 0.96" x 4.29" (4.72 x 2.44 x 10.9 cm)
WEIGHT: 3.52 oz. (100g) w/alkaline // 2.88 oz. (82g) w/lithium
COLOR: Coyote



ITEM #	DESCRIPTION
14975	Sidewinder Boot - Includes (2) "AA" alkaline batteries



SIDEWINDER ACCESSORIES

DESCRIPTION	SIDEWINDER	SIDEWINDER COMPACT II	SIDEWINDER STALK	SIDEWINDER BOOT
Helmet Clip - Black 	-	-	14303	-
Arc Rail Clip - Coyote 	-	-	14304	-
Hook and Loop Adapter Plate - Coyote 	-	-	14305	-
Helmet Mount - Coyote 	14055	14055	14055	14055
Rail Mount for Helmet - Coyote 	14057	14057	14057	14057
Hook and Loop Mount 	14073	14073	14073	14073
Contour Arc Rail Mount 	14114	14114	14114	14114
Night Vision Goggle Mount - Tactical (works with DoD, NATO, & ISAF combat helmets) 	14155	14155	14155	14155
Night Vision Goggle Mount - Aviation (works with HGU-84 rotary wing aircrew helmets) 	14135	14135	14135	14135
Safety Wand - Glow in the dark 	14902	14902	-	-
Elastic Headstrap 	-	14059	-	14059
E-Mount (ACH, ECH, MICH, LWH compatible) 	14136	14136	14136	14136
E-Mount (Includes E-Mount, MOLLE Retainer and paracord) 	14137	14137	-	14137
Paracord 	14138	14138	-	14138
Sidewinder Rescue Kit (Includes MOLLE Retainer and paracord) 	14139	14139	-	14139
Helmet Mount Kit - Helmet Mount, Headstrap, and MOLLE plate 	14112	14112	-	14112
Rail Mount Kit - Includes Rail Mount, Headstrap and MOLLE plate 	14113	14113	-	14113
MOLLE Retainer Replacement 	14030	-	-	-
CR123A Batteries 	2pk - 85175 // 6pk - 85180 12pk - 85177 // 400pk - 8517			-

HEADLAMP SERIES //

HANDS-FREE LIGHTING SPECIALISTS
BECAUSE WORK IS TOUGH ENOUGH WITHOUT
HAVING TO WORRY ABOUT YOUR LIGHTING

Streamlight headlamps are available in a complete line suited to fill the needs of everyone from heavy industrial use to casual hiker. We build features into our lights that help you light your way exactly how and where you need. Spot beams for distance or flood beams for area lighting, and USB or multi-fuel options allowing you to chose the perfect light for your needs.

PROTAC® 2.0 HEADLAMP



ENDURO® PRO USB



ENDURO® PRO HAZ-LO®



BANDIT® PRO



STREAMLIGHT THE WIDEST RANGE OF HANDS-FREE LIGHTING TOOLS

Streamlight proudly builds headlamps for all types of users... from those needing safety-rated models for use in hazardous locations or the night shift worker needing a little extra light to set up a work site. Our choices of beam types, light output and run time ensures you'll be able to find exactly the light you need.

SPOT / FLOOD

MODELS

KEY ATTRIBUTES:
Multi-Function
Task Lighting
General Use
Multi-Purpose



RECHARGEABLE

USB HAZ-LO Headlamp
Double Clutch USB
Twin-Task USB Headlamp
Enduro Pro USB

NON - RECHARGEABLE

Double Clutch Alkaline
Trident - Div. 2
Enduro Pro
Enduro Pro HAZ-LO

FLOOD

MODELS

KEY ATTRIBUTES:
Arm's Length
Task Lighting
Wide, Smooth Light

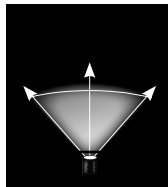

RECHARGEABLE

Bandit
ProTac HL USB Headlamp
ProTac 2.0 Headlamp

NON - RECHARGEABLE

Bandit Pro
Septor - Div. 2
ProTac HL Headlamp

SPOT

MODELS

KEY ATTRIBUTES:
Down Range
Long Distance

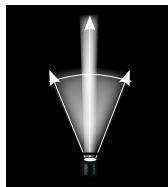

RECHARGEABLE

QB

NON - RECHARGEABLE

Argo - Div. 2
3AA HAZ-LO Headlamp
Enduro

SPECIALTY / COLOR LEDs

MODELS

KEY ATTRIBUTES:
Preserve Night Vision
Won't Spook Game

RECHARGEABLE

Bandit
Bandit Pro

NON - RECHARGEABLE

Enduro Pro
Green Trident

PROTAC HL HEADLAMPS

DELIVERING HIGH-LUMEN PERFORMANCE AND LONG-RANGE LIGHTING

PROTAC® 2.0 HEADLAMP

	HIGH	MEDIUM	LOW
LUMENS:	2,000	650	110
CANDELA:	14,500	4,200	750
DISTANCE:	241m	130m	55m
RUN TIME:	2.25h	4.5h	25h

TEN-TAP® Programmable - choose from three programs:

- high/med/low
- high only
- low/high



2,000
LUMENS

The high-performance ProTac 2.0 Headlamp produces 2,000 lumens without sacrificing run time. Powered by an SL-B50® protected Li-Ion rechargeable battery pack with onboard safety control circuit that charges inside the light using a USB-C cord. TEN-TAP® Programmable switch. IP64-rated; dust-tight and water resistant.

BATTERY: SL-B50 protected Li-Ion USB battery pack

SIZE: 4.92" x 1.46" x 2.56" (12.5 x 3.7 x 6.5 cm)

WEIGHT: 10.48 oz. (297g)

COLOR: Black



Metal sleeve protects the USB-C port. Slide to the right to access.

SL-B50 charges in the light directly via USB-C port battery pack. Charges in 6 hours



ITEM #	DESCRIPTION
89001	ProTac 2.0 Headlamp - Includes SL-B50 battery pack, USB-C cord, elastic and rubber straps
22111	SL-B50 battery pack - 1pk
22112	SL-B50 battery pack - 2pk
22084	USB-C Cord

STREAMLIGHT HEADLAMP SERIES



PROTAC HL® USB HEADLAMP

This is the perfect rechargeable headlamp for when your task requires both hands and a bright light with a wide, long-range beam. 90° tilting head reduces neck fatigue. TEN-TAP Programming lets you choose from three operating modes. IPX4-rated; water-resistant; 1m impact-resistance tested. Multi-fuel capability: accepts rechargeable lithium-ion battery or SL-B26 USB battery pack.

BATTERY: Uses rechargeable lithium-ion battery (included); also accepts SL-B26 Li-Ion USB battery pack
SIZE: 4.03" x 1.20" x 3.12" (10.24 x 3.05 x 7.92 cm)
WEIGHT: 8.1 oz. (230g)
COLOR: Black



ITEM #	DESCRIPTION
61305	ProTac HL USB Headlamp - Clam
61307	ProTac HL USB Headlamp - Box
61306	ProTac HL USB Headlamp 120V AC - Clam

	HIGH	MEDIUM	LOW
LUMENS:	1,000	400	65
CANDELA:	13,500	5,400	900
DISTANCE:	232m	147m	60m
RUN TIME:	1.5h	2.75h	20h

MULTI-FUEL DESIGN:

Runs on lithium-ion battery or SL-B26 battery pack

TEN-TAP® Programmable - choose from three programs:
 • high/med/low
 • high only
 • low/medium/high



Includes a rubber hard hat strap

PROTAC HL® HEADLAMP

The perfect light for when your task requires both hands and a bright light with a wide, long-range beam. 90° tilting head reduces neck fatigue. TEN-TAP programming lets you choose the order of operating modes. IPX4 rated; water resistance; 1 meter impact-resistance tested. Maximum light output throughout battery life.

BATTERY: (2) CR123A lithium
SIZE: 3.66" x 1.2" x 2.6" (2.54 x 3.05 x 6.6 cm)
WEIGHT: 6.6 oz. (187g)
COLOR: Black

ITEM #	DESCRIPTION
61304	ProTac HL Headlamp - Includes CR123A lithium batteries, rubber and elastic straps

	HIGH	MEDIUM	LOW
LUMENS:	635	105	20
CANDELA:	8,500	1,450	280
DISTANCE:	184m	76m	33m
RUN TIME:	1.75h	8h	36h

TEN-TAP® Programmable - choose from three programs:
 • high/med/low
 • high only
 • low/medium/high



Includes a rubber hard hat strap

BANDIT®

Ultra lightweight, weather-resistant headlamp provides 180 lumens of widespread light. It features a large button for easy actuation, and a lithium polymer USB rechargeable battery. A hat clip adapter lets you attach the light on the brim of your hat or to add additional downward adjustability.

BATTERY: Rechargeable lithium polymer
SIZE: 2.7" x 0.75" x 1.13" (6.85 x 1.9 x 2.87cm)
WEIGHT: 1.3 oz. (36.8g)
COLOR: Yellow, Black or Coyote

ITEM #	DESCRIPTION
61700	Bandit - Includes micro-USB cord - Yellow
61702	Bandit - Includes micro-USB cord - Black
61706	Bandit - Includes micro-USB cord - Coyote with Red LED
61707	Bandit - Includes micro-USB cord - Coyote with Green LED
61703	Bandit - Includes elastic headstrap, rubber hard hat strap, 3M® Dual Lock® and USB cord - Yellow - Box
61437	Hard Hat Clips for 1" Straps

3M® and Dual Lock® are registered Trademarks of the 3M Company.



Includes a snap-in hat clip adapter to attach the light on the brim of a baseball hat or to add additional downward adjustability when using the headband.

WHITE LED	HIGH	LOW
LUMENS:	180	35
RUN TIME:	2h	9.5h
EMERGENCY FLASH - 180 LUMENS		

Yellow & Black Models: White LED



Coyote Models: White/Red LED
White/Green LED

GREEN LED	HIGH	LOW
LUMENS:	135	25
RUN TIME:	3h	13.5h
EMERGENCY FLASH - 180 LUMENS		
RED LED	HIGH	LOW
LUMENS:	45	10
RUN TIME:	2.5h	10h



Industrial Mode for both Bandit Models: Two hardhat mounting options:

Rubber strap

3M® Dual Lock® for strapless mounting



BANDIT® PRO

The Bandit Pro is an ultra-lightweight, weather-resistant, personal area/work light featuring a large, easy-to-use push button and a lithium polymer rechargeable battery. It includes a snap-in clip adapter to attach the light to the visor on a hat and it also adds additional downward adjustability. High, low and emergency flash modes. Battery life indicator: with approx. 5 minutes of remaining run time, light enters a sequence of blinking three times and remaining on for 30 seconds until it shuts off.

BATTERY: Rechargeable lithium polymer
SIZE: 2.7" x 0.97" x 1.13" (6.85 x 2.46 x 2.87cm)
WEIGHT: 1.6 oz. (45.4g)
COLOR: Yellow or Black

ITEM #	DESCRIPTION
61710	Bandit Pro - Includes USB cord - Yellow - Clam
61714	Bandit Pro - Includes USB cord - Black - Clam
61716	Bandit Pro - Includes elastic headstrap, rubber hard hat strap, 3M® Dual Lock® and USB cord - Yellow - Box
61437	Hard Hat Clips for 1" Straps

3M® and Dual Lock® are registered Trademarks of the 3M Company.

	HIGH	LOW
LUMENS:	180	35
RUN TIME:	4.5h	21h
EMERGENCY FLASH - 180 LUMENS		

Attaches to visor



Multi-function push-button switch with charge indicator shines red when charging and green when charged



ENDURO® PRO USB

Save money over the cost of standard batteries with the Enduro Pro USB rechargeable headlamp. You'll always have the light you need with Spot and Flood beams, each with high, medium and low modes. Spot gives you a bright, focused beam and Flood gives you soft, area illumination that won't tire your eyes on a long job.

BATTERY: Lithium polymer cell
SIZE: 1.85" x 2.19" x 1.7" (4.7 x 5.56 x 4.32 cm)
WEIGHT: 3.6 oz. (102g)
COLOR: Yellow

ITEM #	DESCRIPTION
61435	Enduro Pro USB - Includes micro-USB cord, elastic head strap
61436	Enduro Pro USB - Includes micro-USB cord, elastic head strap, rubber hard hat strap, 3M® Dual Lock®
61437	Hard Hat Clips for 1" Straps 

3M® and Dual Lock® are registered Trademarks of the 3M Company.

SPOT	HIGH	MEDIUM	LOW	FLOOD	HIGH	MEDIUM	LOW
LUMENS:	200	90	25	LUMENS:	145	50	15
CANDELA:	2,080	890	250	CANDELA:	220	80	30
DISTANCE:	91m	60m	32m	DISTANCE:	30m	18m	11m
RUN TIME:	6.25h	19h	48h	RUN TIME:	7h	21h	48h



Industrial Model: Two hardhat mounting options:

Rubber strap

3M® Dual Lock® for strapless mounting



ENDURO[®] PRO

This low-profile headlamp has multiple modes to cover a variety of tasks with just one light: spot for a focused beam, flood for soft area illumination that won't tire your eyes and red light to preserve night vision. Multi-function switch remembers the last mode used. 45° tilting head design. IPX4-rated; water-resistant.

Industrial model:

Two hardhat mounting options:

Rubber strap

3M[®] Dual Lock[®] for strapless mounting



BATTERY: (3) "AAA" alkaline
SIZE: 1.85" x 2.19" x 1.45" (4.7 x 5.56 x 3.68 cm)
WEIGHT: 3.4 oz. (96.38g)
COLOR: Yellow or Coyote

ITEM #	DESCRIPTION
61420	Enduro Pro - Includes AAA batteries, elastic headstrap - Clam - Yellow
61421	Enduro Pro - Includes AAA batteries, elastic headstrap - Box - Yellow
61425	Enduro Pro - Includes AAA batteries, elastic headstrap - Clam - Coyote
61422	Enduro Pro Industrial - Includes AAA batteries, rubber hard hat strap, elastic head strap, 3M [®] Dual Lock [®] - Box - Yellow
61437	Hard Hat Clips for 1" Straps

3M[®] and Dual Lock[®] are registered Trademarks of the 3M Company.



ENDURO[®]

The Enduro is a lightweight and super comfortable headlamp. It features an integrated rubber/elastic head strap for versatility. Unbreakable polycarbonate lens. IPX7-rated; waterproof; 2m impact resistance tested. Maximum light output throughout battery life.

BATTERY: (2) "AAA" alkaline
SIZE: 1.3" x 2.25" x 1.6" (3.25 x 5.7 x 4 cm)
WEIGHT: 2.75 oz. (78.5g)
COLOR: Black

ITEM #	DESCRIPTION
61400	Enduro - Includes (2) AAA batteries, visor clip and elastic strap

SPOT	HIGH	MEDIUM	LOW
LUMENS:	200	75	25
CANDELA:	2,250	825	300
DISTANCE:	95m	57m	35m
RUN TIME:	6h	14h	38h

FLOOD	HIGH	MEDIUM	LOW
LUMENS:	135	45	15
CANDELA:	210	80	20
DISTANCE:	29m	18m	9m
RUN TIME:	6h	14h	38h

Yellow Model:
White /Red LED



Coyote Model:
White /Green LED



	HIGH	LOW
LUMENS:	50	10
CANDELA:	1,100	285
DISTANCE:	66m	33m
RUN TIME:	5.5h	25h



Visor clip attaches to the brim of your hat, coat, or car visor.

STREAMLIGHT HEADLAMP SERIES



ENDURO® PRO HAZ-LO®

This intrinsically safe, low-profile headlamp has multiple modes to cover a variety of tasks: spot for a focused beam, flood for soft area illumination that won't tire your eyes and spot/flood combo for increased light output. Multi-function switch is easy to use with gloved hands. IP67-rated; dust tight and waterproof to 1m for 30 minutes.

	SPOT	FLOOD	COMBO
LUMENS:	160	160	235
CANDELA:	1,320	100	-
DISTANCE:	73m	20m	-
RUN TIME:	5h	5h	4.75h



Class I, II, Div. 1, Grps. A, B, C, D, E, F, G;
Class III, Class I, Zn O, Grps. IIC, Exia
T-Code: T4



Permissible Portable Headlamp Assembly
App. No. 20-AD70001-0
Tested for use in methane-air mixtures only

BATTERY: (3) "AAA" alkaline
SIZE: 2" x 2.19" x 1.5" (5.08 x 5.68 x 3.81 cm)
WEIGHT: 3.5 oz. (99.2g)
COLOR: Yellow



Low-profile design

ITEM #	DESCRIPTION
61424	Enduro Pro HAZ-LO - Includes alkaline batteries, elastic headstrap, rubber hard hat strap and 3M® Dual Lock®
61437	Hard Hat Clips for 1" Straps

3M® and Dual Lock® are registered Trademarks of the 3M Company.



Spot

Flood

Combo

Two hardhat mounting options:

Rubber strap

3M® Dual Lock® for strapless mounting



RECHARGEABLE HEADLAMP WITH CLASS I, DIV 1 SAFETY RATINGS



USB HAZ-LO® HEADLAMP

Rechargeable Class I, Div. 1 headlamp! Multiple modes cover a variety of tasks with just one light: spot for a focused beam, flood for soft area illumination that won't tire your eyes and spot/flood combo for increased light output. Multi-function switch is easy to use with gloved hands. IP67-rated; dust-tight and waterproof to 1m for 30 minutes. Charge status indicator in bezel: red = charging, green = charged.

BATTERY: Lithium-ion
SIZE: 1.72" x 3.25" x 1.75" (4.36 x 8.25 x 4.45 cm)
WEIGHT: 4.1 oz. (116.2g)
COLOR: Yellow

	SPOT	FLOOD	COMBO
LUMENS:	190	120	250
CANDELA:	2,000	90	-
DISTANCE:	89m	19m	-
RUN TIME:	7.5h	13h	7h



Class I, II, Div. 1, Grps. A, B, C, D, E, F, G
 Class III, Class I, Zn O, Group IIC, Exia
 T-Code: T4



ITEM #	DESCRIPTION
61460	USB HAZ-LO headlamp - Includes 120V AC cord, elastic headstrap, rubber hard hat strap and 3M® Dual Lock®
61463	USB HAZ-LO Headlamp - Includes 120V AC charge cradle, elastic headstrap, rubber hard hat strap and 3M® Dual Lock®
61465	Charge Cradle
61469	120V AC Bank Charger
61437	Hard Hat Clips for 1" Straps 

3M® and Dual Lock® are registered Trademarks of the 3M Company.

Two hardhat mounting options:

Rubber strap

3M® Dual Lock® for strapless mounting



CHARGING



CHARGED



5-unit bank charger



Charge cradle

STREAMLIGHT HEADLAMP SERIES

3AA HAZ-LO® HEADLAMP

This compact, long-running, high-performance headlamp meets the stringent requirements of Div. 1 hazardous locations. Exceptional light output with a long run time to get you through your shift. Unbreakable, O-ring sealed lens. Easy operation even when wearing heavy gloves. Impact-resistant housing – 1 meter drop-test verified. Intrinsically safe.

BATTERY: (3) "AA" alkaline
SIZE: 1.88" x 2.5" x 3.08" (4.76 x 6.35 x 7.82 cm)
WEIGHT: 7.1 oz. (201.28g)
COLOR: Yellow

LUMENS:	270
CANDELA:	5,600
DISTANCE:	150m
RUN TIME:	8h



Includes a rubber head strap that ensures a non-slip grip for hard hats.



Class I, Div. 1, Grps. A, B, C, D;
 Class II, Div. 1, Grps. E, F, G
 Class III, T-Code: T4

ITEM #	DESCRIPTION
61200	3AA HAZ-LO Headlamp - Includes alkaline batteries, rubber & elastic straps

SEPTOR®

The Septor headlamp is your ideal choice when you need a hands-free flood light for close-up tasks or tasks at arm's length. It gives you 120 lumens of a soft, wide beam to illuminate your work area.

	HIGH	MEDIUM	LOW
LUMENS:	120	45	13
CANDELA:	900	375	100
DISTANCE:	60m	35m	20m
RUN TIME:	3.5h	10h	55h



Includes a rubber head strap that ensures a non-slip grip for hard hats.



Class I, Div. 2, Grps. A, B, C, D;
 Class II, Div. 2, Grps. F, G,
 Class III, T-Code: T5

BATTERY: (3) "AAA" alkaline
SIZE: 1.75" x 2.70" x 2.40" (4.45 x 6.85 x 6.09 cm)
WEIGHT: 5.5 oz. (156g)
COLOR: Yellow

ITEM #	DESCRIPTION
61052	Septor - Includes alkaline batteries, rubber & elastic straps

ARGO®

Featuring an intense, long-distance beam for down range illumination with 3 levels of output.

	HIGH	MEDIUM	LOW
LUMENS:	150	100	45
CANDELA:	9,250	6,375	2,750
DISTANCE:	190m	160m	103m
RUN TIME:	3h	4.5h	30h



Class I, Div. 2, Grps. A, B, C, D;
 Class II, Div. 2, Grps. F, G,
 Class III, T-Code: T5

BATTERY: (3) "AAA" alkaline
SIZE: 1.75" x 2.70" x 2.40" (4.45 x 6.85 x 6.09 cm)
WEIGHT: 5.4 oz. (153g)
COLOR: Yellow

ITEM #	DESCRIPTION
61301	Argo - Includes alkaline batteries, rubber & elastic straps

TRIDENT®

The Trident multi-purpose headlamp offers the versatility of switching between either a bright light to illuminate objects at a distance (126 meters) or a soft flood light for tasks at arm's length.



Class I, Div. 2, Grps. A, B, C, D;
Class II, Div. 2, Grps. F, G
Class III, T-Code: T5

BATTERY: (3) "AAA" alkaline
SIZE: 1.75" x 2.7" x 2.4" (4.45 x 6.85 x 6.09 cm)
WEIGHT: 5.5 oz. (156g)
COLOR: Yellow or Green

ITEM #	DESCRIPTION
61050	Trident - White LEDs - Includes alkaline batteries, rubber & elastic straps - Yellow
61051	Trident - White and Green LEDs - Includes alkaline batteries, rubber & elastic straps - Green

	HIGH	MEDIUM	LOW
LUMENS:	80	35	11
CANDELA:	4,000	385	120
DISTANCE:	126m	39m	22m
RUN TIME:	5h	10h	53h

GREEN MODEL	HIGH	MEDIUM	LOW
LUMENS:	80	25	6
CANDELA:	4,000	275	55
DISTANCE:	126m	39m	15m
RUN TIME:	5h	19.5h	63h



Includes a rubber hard hat strap



STREAMLIGHT HEADLAMP SERIES

DOUBLE CLUTCH® USB

This dual-power, dual-function, dual-output headlamp gives you the flexibility of using either a USB-rechargeable battery or three AAA alkaline batteries. It also lets you choose either a spot or a flood beam, both with high and low mode. It's lightweight and long-running with a 60° tilting head. Unbreakable lens. IPX4-rated; water-resistant. 2 meter impact resistance tested.

BATTERY: Rechargeable Lithium Polymer pack or (3) "AAA" alkaline or lithium batteries
SIZE: 1.75" x 2.50" x 1.66" (4.44 x 6.35 x 4.22 cm)
WEIGHT: 3.7 oz. (105g)
COLOR: Yellow or Black

	HIGH	LOW
LUMENS:	125	30
SPOT CANDELA:	1,700	400
SPOT DISTANCE:	82m	40m
FLOOD CANDELA:	250	70
FLOOD DISTANCE:	31m	4m
RUN TIME: LITH POLYMER	3.5h	10h
RUN TIME: ALKALINE	6h	18h



YELLOW	BLACK	DESCRIPTION
61602	61603	Double Clutch USB - 120V AC
61600	61601	Double Clutch USB - with micro-USB Cord (only)
61607	61608	Double Clutch - Alkaline Model
61604		Lithium polymer battery



Includes a rubber hard hat strap

SHIFT BEAMS //

• **SHIFTS EASILY TO SPOT OR FLOOD MODES WITH THE TURN OF THE WRIST**



• **GLOVE-FRIENDLY**
 • **FACECAP ROTATION**

SHIFT BATTERIES //

• **USB RECHARGEABLE LITHIUM POLYMER OR "AAA" BATTERIES**



SHIFT BRIGHTNESS //

• **DOUBLE SHIFT FOR HIGH TO LOW IN SPOT OR FLOOD MODES.**
 • **125 LUMENS ON HIGH. 30 LUMENS ON LOW.**



HEADLAMP ACCESSORIES

DESCRIPTION	PART #	GOES WITH
Li-ion Battery Stick 	74175	ProTac HL USB Headlamp, Twin-Task USB Headlamp
CR123A Lithium Batteries - 2pk 	85175	ProTac HL Headlamp
CR123A Lithium Batteries - 6pk	85177	
CR123A Lithium Batteries - 12pk	85179	
SL-B26 Li-Ion USB Battery Pack Charge Cradle (batteries & cord sold separately) 	22100 22010 22011	ProTac HL USB Headlamp
120V AC USB Charge Cord 	22071	ProTac HL USB Headlamp, Double Clutch USB, Twin-Task USB Headlamp
SL-B26 Battery Packs 	22101 - 1pk 22102 - 2pk 22105 - 8pk	ProTac HL USB Headlamp
40" (101.6 cm) Micro USB Cord  22" (55.88 cm) Micro USB Cord	22070 22081	ProTac HL USB Headlamp, Double Clutch USB, Bandit, Bandit Pro, Enduro Pro USB, USB HAZ-LO Headlamp, Twin-Task USB Headlamp



TWIN-TASK® USB HEADLAMP

This is a multi-use USB rechargeable headlamp that provides a spot beam or a flood light to cover a variety of tasks. Use the spot beam for distance lighting. When you have an up-close task, use the flood light for smooth, diffused illumination to fill your work area with light. 120° tilting head reduces neck fatigue. IPX4 water-resistant. Ergonomically designed for maximum comfort.

BATTERY: Rechargeable Lithium-ion- uses the same battery (#74175) as the Strion® series

SIZE: 1.35" x 2.125" x 2.67" (3.43 x 5.4 x 6.78 cm)

WEIGHT: 6.1 oz. (173g)

COLOR: Red

SPOT	HIGH	MEDIUM	LOW
LUMENS:	375	175	50
CANDELA:	3,650	1,850	440
DISTANCE:	121m	86m	42m
RUN TIME:	4.75h	8.5h	20h



Low-profile, ergonomically balanced design; contoured battery pack for comfort.

ITEM #	DESCRIPTION
51063	Twin-Task USB Headlamp - Includes USB cord & elastic head strap - Clam
51064	Twin-Task USB Headlamp - Includes USB cord & elastic head strap - Box

FLOOD	HIGH	LOW
LUMENS:	250	125
CANDELA:	160	80
DISTANCE:	25m	18m
RUN TIME:	5h	9h



STYLUS & SPECIALTY SERIES //

REDEFINING PORTABLE LIGHTING

**YOUR JOB HAS CHANGED, BUT THE NEED FOR SMALL,
VERSATILE AND EFFECTIVE LIGHTING HASN'T.**

We pride ourselves on identifying a need and building a product to suit it. Our Stylus is exactly one of those products. Small, compact, a long runtime and easily stowed. It's been seen just about everywhere from garages to TSA lanes. It's evolved into a full family of Stylus products with unique attributes that make them extra functional and suited for a variety of tasks.

STYLUS®



STYLUS PRO®



MACROSTREAM® USB



STREAMLIGHT JR. F-STOP®



POCKET MATE® USB



STREAMLIGHT MICROSTREAM SERIES



MICROSTREAM®

The MicroStream is small enough for you to discreetly keep it in your pocket, or clip it to a ball cap for hands-free use. This versatile tool is perfect for supervisors who don't need a flashlight on a daily basis, or for those who don't want to be weighed down by larger lighting tools.

BATTERY: (1) "AAA" alkaline
SIZE: 3.6" x 0.6" (9.14 x 1.5 cm)
WEIGHT: 1.10 oz. (31.2g)
COLOR: Black or Red

ITEM #	DESCRIPTION
66318	MicroStream - Includes alkaline batteries & lanyard - Black
66323	MicroStream - Includes alkaline batteries & lanyard - Red

LUMENS:	45
CANDELA:	420
DISTANCE:	41m
RUN TIME:	2.25h



MICROSTREAM® USB

The MicroStream USB is small enough for you to discreetly keep it in your pocket, or clip it to a ball cap for hands-free use. It's USB rechargeable so you can conveniently charge it via virtually any USB power source. To charge it, slide the head cover forward to expose the micro-USB port.

BATTERY: Lithium-ion
SIZE: 3.87" x 0.61" (9.83 x 1.56 cm)
WEIGHT: 1.2 oz. (34.1g)
COLOR: Black, Red, Blue or Coyote

ITEM #	DESCRIPTION
66601	MicroStream USB - Includes USB cord & lanyard - Clam - Black
66604	MicroStream USB - Includes USB cord & lanyard - Box - Black
66602	MicroStream USB - Includes USB cord & lanyard - Clam - Red
66605	MicroStream USB - Includes USB cord & lanyard - Box - Red
66603	MicroStream USB - Includes USB cord & lanyard - Clam - Blue
66606	MicroStream USB - Includes USB cord & lanyard - Box - Blue
66608	MicroStream USB - Includes USB cord & lanyard - Clam - Coyote
66609	MicroStream USB - Includes USB cord & lanyard - Box - Coyote
66607	Lithium-ion battery
22070	40" (101.6 cm) Micro USB cord
22071	120V AC USB cord

	HIGH	LOW
LUMENS:	250	50
CANDELA:	1,150	250
DISTANCE:	68m	31m
RUN TIME:	1.5h	3.5h



Sliding metal sleeve protects micro USB port

THE MACROSTREAM USB
ULTRA-COMPACT SIZE
MEETS UNPARALLELED
PERFORMANCE

MACROSTREAM® USB

High-powered ultra-compact lithium-ion battery-powered flashlight. It fits in the palm of your hand or comfortably in your pocket and provides unparalleled performance for its size. Durable aluminum construction; IPX4-rated; water-resistant.

BATTERY: Lithium-ion
SIZE: 4.50" x 0.83" (11.43 x 2.1 cm)
WEIGHT: 2.2 oz. (62.4g)
COLOR: Black

	HIGH	LOW
LUMENS:	500	50
CANDELA:	2,000	220
DISTANCE:	90m	30m
RUN TIME:	2h	8h



Clip onto brim of hat for hands-free use



Metal sleeve protects charge port; slide sleeve forward to reveal charge port

ITEM #	DESCRIPTION
66320	MacroStream USB - Includes micro USB cord
66321	Lithium-ion battery - MacroStream USB
22070	40" (101 cm) Micro USB Cord
22071	120V AC USB cord

STREAMLIGHT
STYLUS SERIES



THE STYLUS PRO SERIES
MORE OPTIONS
TO USE IN EVEN MORE
PLACES & WAYS!



WHITE LED	HIGH	LOW
LUMENS:	350	90
CANDELA:	2,950	840
DISTANCE:	109m	58m
RUN TIME:	1.5h	3.5h



Sliding metal sleeve protects micro USB port

STYLUS PRO[®] USB UV

The Stylus Pro USB UV features a 400nm UV LED that is ideal for HVAC leak detection, forensic investigations or identifying fraudulent documents.

BATTERY: Lithium-ion
SIZE: 5.95" x 0.63" (15.1 x 1.6 cm)
WEIGHT: 1.8 oz. (51g)
COLOR: Black

ITEM #	DESCRIPTION
66148	Stylus Pro USB UV - 120V AC with holster
66149	Stylus Pro USB UV - Includes Micro USB cord & holster

STYLUS PRO[®] USB

The Stylus Pro USB has a new body style and is shining brighter! It features a slimmer profile to fit in your pocket so you can take it with you wherever you go. Perfect for inspections, reading work orders or completing paperwork. IPX4-rated; water-resistant.

BATTERY: Lithium-ion
SIZE: 5.95" x 0.63" (15.1 x 1.6 cm)
WEIGHT: 1.8 oz. (51g)
COLOR: Black

ITEM #	DESCRIPTION
66133	Stylus Pro USB - 120V AC with holster
66134	Stylus Pro USB - Includes USB cord & holster
66029	Nylon Holster
22070	40" (101 cm) Micro USB Cord
22071	120V AC USB cord

400NM UV LED	
OUTPUT:	250mW
RUN TIME:	2.5h



Sliding metal sleeve protects micro USB port



LUMENS:	100
CANDELA:	950
DISTANCE:	62m
RUN TIME:	8h

STYLUS PRO[®]

Compact size, durable construction and optimum beam output make this an ideal light for multiple tasks. Unbreakable lens. O-ring sealed. IPX4-rated; water-resistant. 1m impact-resistance tested. Removable pocket clip.

BATTERY: (2) "AAA" alkaline
SIZE: 5.3" x 0.6"(13.4 x 1.5 cm)
WEIGHT: 1.64 oz. (46.9g)
COLOR: Matte Black, Silver, Red, Blue, Lime Green, Orange

ITEM #	DESCRIPTION
66118	Stylus Pro - Includes alkaline batteries - Matte Black
66121	Stylus Pro - Includes alkaline batteries - Silver
66120	Stylus Pro - Includes alkaline batteries - Red
66122	Stylus Pro - Includes alkaline batteries - Blue
66129	Stylus Pro - Includes alkaline batteries - Lime Green
66128	Stylus Pro - Includes alkaline batteries - Orange





STYLUS®

This bright, long-running LED penlight has a long battery life, and goes anywhere you need it. IPX4-rated; water-resistant. Removable pocket clip.

BATTERY: (3) "AAAA" alkaline
SIZE: 6.21" x 0.375" (15.17 x 0.95 cm)
WEIGHT: 1.1 oz. (31g)
COLOR: Black, Gold, Silver, Red or Blue

LED COLOR	WHITE	GREEN	BLUE	RED
LUMENS:	11	7	2	2
CANDELA:	140	59	110	53
DISTANCE:	24m	15m	21m	15m
RUN TIME:	24h	24h	24h	24h



SAFETY RATED MODEL OFFERED



SAFETY RATED
MODEL OFFERED



Intrinsic Safety for Haz. Loc.
Class I, Div. 1,
Grps. A, B, C, D, T3C
"Classified"



Intrinsic Safety for Haz. Loc.
Class I, Div. 1,
Grps. A, B, C, D, T3C
"Exia"

ITEM #	DESCRIPTION
65006	Stylus - Black - Red LED
65012	Stylus - Silver - White LED
65018	Stylus - Black - White LED
65020	Stylus - Black - Green LED
65022	Stylus - Black - Blue LED
65024	Stylus - Gold - White LED
65035	Stylus - Red - White LED
65050	Stylus - Blue - White LED
65058	Stylus - UL Listed - Black White LED
65030	AAAA alkaline batteries - 6pk
65031	Glare Guard
65905	Nylon Holster
72024	Lanyard with push-button slide



THE STYLUS SERIES ELIMINATES HARD-TO-SEE NOOKS AND CRANNIES AND LIGHTS THE WAY

STYLUS REACH®

	WHITE
LUMENS:	11
CANDELA:	140
DISTANCE:	24m
RUN TIME:	24h

Twist and turn the flexible cable into any position to light the most out-of-the-way places.



BATTERY: (3) "AAAA" alkaline
SIZE: 14" x 0.375" (35.5 x 0.95 cm)
WEIGHT: 1.7 oz. (48g)
COLOR: Black or Silver

ITEM #	DESCRIPTION
65618	Stylus Reach - Black
65658	Stylus Reach - Black - UL Listed
65612	Stylus Reach - Silver
65030	AAAA alkaline batteries - 6pk



Intrinsic Safety for Haz. Loc.
Class I, Div. 1,
Grps. A, B, C, D, T3C
"Classified"



Intrinsic Safety for Haz. Loc.
Class I, Div. 1,
Grps. A, B, C, D, T3C
"Exia"

STYLUS REACH® 18

	WHITE
LUMENS:	11
CANDELA:	140
DISTANCE:	24m
RUN TIME:	24h

A textured grip for non-slip handling makes it easier to maneuver the light in slippery or wet conditions.

Features a white LED mounted on a 18" cable (providing 25" of reach) that allows you to see into the tightest spots. IPX4-rated; for water-resistance. Pocket clip.

BATTERY: (3) "AAAA" alkaline
SIZE: 25.5" x 0.375" (64.77 x 0.95 cm)
WEIGHT: 2.5 oz. (70g)
COLOR: Black

ITEM #	DESCRIPTION
65418	Stylus Reach 18
65030	AAAA alkaline batteries - 6pk



CLIPMATE® USB

This multi-function light clips to pocket or cap for hands-free use. Recharges by plugging into USB port or optional AC wall adaptor. IPX4-rated; water-resistant. 1 meter impact-resistance tested.

BATTERY: Lithium polymer cell
SIZE: 3.20" x 1.39" x 0.65" (8.1 x 3.5 x 1.7 cm)
WEIGHT: 1.9 oz. (53.8g)
COLOR: Black

WHITE LED	HIGH	LOW	RED LED	HIGH	LOW
LUMENS:	70	10	LUMENS:	.5	.2
CANDELA:	500	50	CANDELA:	9	3
DISTANCE:	44m	14m	DISTANCE:	6m	3m
RUN TIME:	3.5h	24h	RUN TIME:	16h	65h

ITEM #	DESCRIPTION
61125	Clipmate USB - Light only
61126	Clipmate USB - 120V AC
22058	120V AC Wall Adapter
61128	Clipmate USB Battery



Flexible, extension cable targets the beam where you need it

Dual LEDs:
 High-intensity white LED
 Night vision red LED





STREAMLIGHT JR. F-STOP®

The Streamlight Jr. F-Stop is a work light that fits in your pocket. It provides a smooth flood beam to illuminate your work area without tiring your eyes. Slide the lens forward for a smooth transition to a spot beam for distance lighting.

BATTERY: (2) "AA" Alkaline or Lithium batteries
SIZE: 6.5" x 1.12" x 0.75" (16.51 x 2.84 x 1.90 cm)
WEIGHT: 4.4 oz. (125g)
COLOR: Black

	FLOOD	SPOT
LUMENS:	250	220
CANDELA:	360	5,600
DISTANCE:	38m	150m
RUN TIME ALK:	6h	6h
RUN TIME LITH:	10h	10h



SPOT

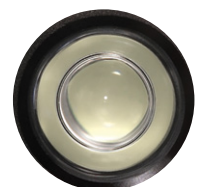

FLOOD

CLAM	BOX	DESCRIPTION
71700	71701	Streamlight Jr. F-Stop - Includes alkaline batteries
	71503	Nylon Holster
	99075	Rubber Helmet Strap

THE LIGHT SEEN IN EVERY TOOL BOX, IS THE LIGHT THAT CAN HELP YOU SEE ANYWHERE

STREAMLIGHT JR.® LED

This is a classic personal light featuring a 2 AA-sized aluminum body with non-slip knurled grip. It's brighter than most traditional 2AA flashlights, and it also has good beam distance capability. It's small enough to fit easily on your belt or tuck into a tool box when you go out on inspections and perform repairs.

BATTERY: (2) "AA" alkaline or lithium

SIZE: 6.5" x 1" x 0.73" (16.51 x 2.54 x 1.85 cm)

WEIGHT: 4.1 oz. (117g)

COLOR: Black

ITEM #	DESCRIPTION
71500	Streamlight Jr. LED with alkaline batteries
71510	Magnetic Clip Holder
71503	Nylon Holster
99075	Rubber Helmet Strap

LUMENS:	225
CANDELA:	2,700
DISTANCE:	104m
RUN TIME ALK:	6h
RUN TIME LITH:	10h



STREAMLIGHT JR.® REACH LED

With its flexible cable and magnetic clip, you can put this handy light anywhere and see anything. Unbreakable lens. IPX4-rated; water-resistance. All openings O-ring sealed. 1 meter impact-resistance tested.

BATTERY: (2) "AA" alkaline

SIZE: 20" x 0.8" x 0.73" (50.8 x 2.03 x 1.85 cm)

WEIGHT: 6.1 oz. (173g)

COLOR: Black

LUMENS:	115
CANDELA:	1,500
DISTANCE:	77m
RUN TIME:	7.5h



ITEM #	DESCRIPTION
71600	Streamlight Jr. Reach LED - Includes alkaline batteries
71510	Magnetic Clip Holder

POCKET MATE® USB

The micro-USB rechargeable Pocket Mate is small in size but big on power - produces 325 lumens. Conveniently fits in your pocket and clips to your lapel or visor for hands-free use. Spring-loaded clip with carabiner shape hangs cleanly on key ring, zipper, etc. Recharges in four hours. IPX4-rated; weather-resistant.

BATTERY: Lithium polymer
SIZE: 2" x 0.5" (5.1 x 1.27 cm)
WEIGHT: 0.5 oz. (14.2g)
COLOR: Silver, Red, Blue, Pink

	HIGH	LOW
LUMENS:	325	45
CANDELA:	1,450	200
DISTANCE:	76m	28m
RUN TIME:	20min	1h



ITEM #	DESCRIPTION
73300	Pocket Mate - Includes micro USB cord - Silver
73301	Pocket Mate - Includes micro USB cord - Red
73302	Pocket Mate - Includes micro USB cord - Blue
73303	Pocket Mate - Includes micro USB cord - Pink



Multi-function push-button switch with charger indicator LED:
 Red = charging; Green = charged

Attach to zippers, keyrings, etc.



Pocket clip attaches to visor for hands-free use





Streamlight, Inc.
 30 Eagleville Road
 Eagleville, PA U.S.A. 19403-3996

streamlight.com // streamlightgear.com
 (800) 523-7488 Toll-Free
 (800) 220-7007 Fax
 (610) 631-0600
 (610) 631-0712 Fax



DISTRIBUTED BY:



The shape, style and appearance of the generally triangular feature on the head of the Stinger® Series is a trademark of Streamlight, Inc.



The silver band that encircles the head of the TLR® Series is a trademark of Streamlight, Inc.

